

## ADJUSTMENTS

Always ensure that the basic settings made by Öhlins are intact.

### 1 Spring Preload

Turn the knob on the hydraulic preload adjuster to set the spring preload. Turn clockwise to increase the preload, turn counter clockwise to decrease it.

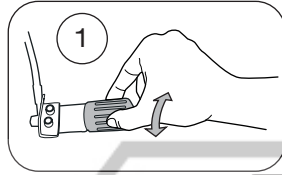

### 2 Rebound

Turn the wheel on the piston shaft above the end eye/bracket. Turn clockwise to increase damping, turn counter clockwise to decrease.

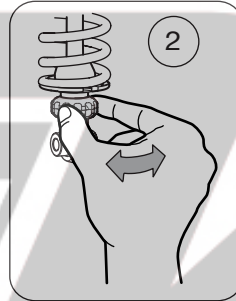

### NOTE!

When delivered the Öhlins shock absorber is dialed to the recommended settings for the specific vehicle model. If you have changed the setting, reset according to the following:

The adjuster has a right hand thread. Turn the adjuster clockwise to fully closed (pos. zero [0]). Turn counter clockwise to open and count the clicks until you reach the recommended number (see Set-up Data).

### CAUTION!

Do not use force, delicate sealing surfaces can be damaged. Handtighten only.

### 3 Length

We recommend you to adjust the length before installing the shock absorber to the vehicle. Use two wrenches. Hold the upper nut with one hand and at the same time loosen the lock nut (lower nut). Turn the end eye/ bracket to the desired length. Lock the lock nut. Tightening torque: 40 Nm

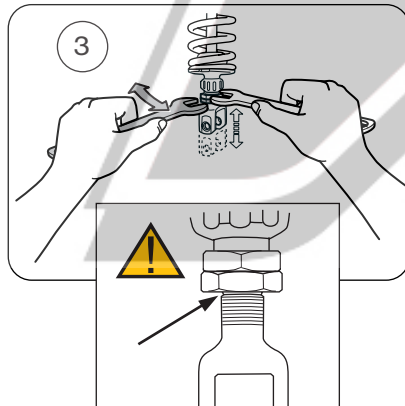

### WARNING!

The adjustable end eye/bracket must not be threaded out more than that the groove is fully visible beneath the lock nut. This is maximum length. After adjusting, make sure that the lock nut is tightened.

# Mounting Instructions

WITH SET-UP DATA

## SHOCK ABSORBER SU708 for Suzuki C800/ VL800

Before installing this shock absorber, check the contents of the kit listed below. If anything is missing, please contact your nearest Öhlins dealer.

### Kit Contents:

	Part No.	Pcs.
Shock absorber	SU708	1
Bracket	20028-01	1
Screw MC6S	01046-01	2
Öhlins Sticker black	00191-13	2
Öhlins Sticker white	00191-20	2
Memo Notes Sticker	01180-01	1
Owner's Manual	07241-02	1

During storage and transportation, especially at high ambient temperature, some of the oil and grease used for assembling may leak and stain the packaging. This is in no way detrimental to the product, wipe off the excessive oil/grease with a cloth.

### Set-up Data

Spring preload	17 mm
Rebound damping	14 clicks

Shock absorber length	310 <sup>0</sup> <sub>-12</sub> mm
Stroke	46,5 mm

Spring	21115-44
Free spring length	150 <sup>0</sup> <sub>3</sub> mm

Before installing this product, read the Öhlins Owner's Manual!

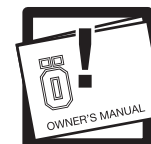

## HOW TO INSTALL

### ⚠ WARNING!

It is advisable to have an Öhlins dealer install the shock absorber.

**1**

Put the motorcycle on a workstand so that the rear wheel barely touches the ground.

### ⚠ WARNING!

Make sure the vehicle is securely supported so that it will not tip.

**2**

Remove the side cover on the right side of the vehicle.

**3**

If necessary, remove the bracket to the CDI-box and fold it out gently, as indicated in the figure.

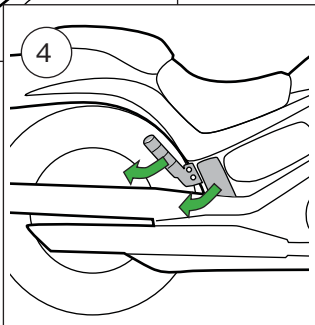
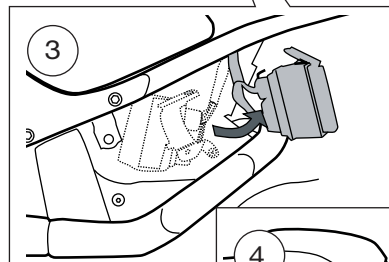
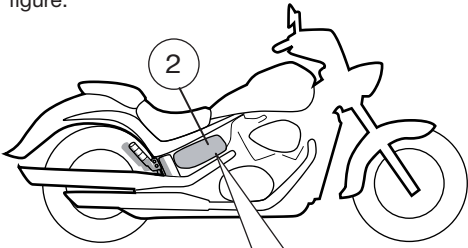

**4**

Loosen the right side passenger foot peg. Gently fold out the cover indicated in the figure.

**5**

On the left side of the vehicle, remove the side cover. Remove the lid, tools and tool box.

**6**

Remove the frame cover and the engine cover.

**7**

Loosen the fuse box bracket and gently fold it out as indicated in the figure.

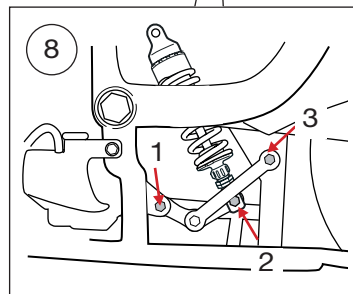
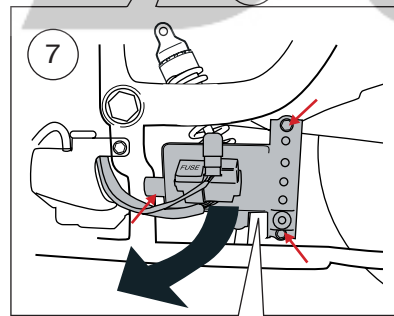
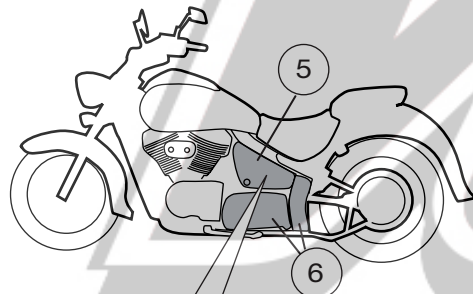

**8**

Loosen the lower attachment of the original shock absorber by removing the screws on the triangle link and pull rods. (Fold out the cover on the right side, see step 4). Remove the triangle link and pull rods as a unit.

**9**

Remove the upper attachment of the original shock absorber. Remove the original shock absorber.

### NOTE!

Recommendation! Before installing the Öhlins shock absorber:

- clean the vehicle thoroughly
- adjust the length of the shock absorber (check the headlight angle after adjusting the length)

**10**

Install the Öhlins shock absorber. Lead the hose around the frame and out on the left side. The shock absorber fill screw should be pointing to the rear. See figure.

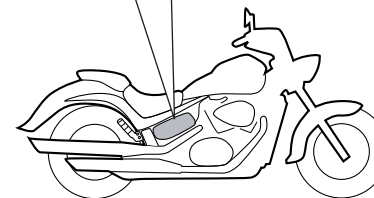
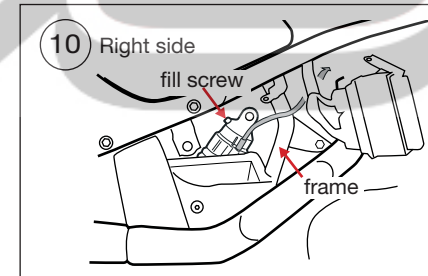

**11**

Attach the upper and lower attachments and the triangle link, but do not tighten yet.

### NOTE!

Lower the motorcycle so that the shock absorber is slightly compressed, before tightening the screws.

**12**

Tighten the screws of the upper and lower attachment and the triangle link.

**13**

Attach the bracket provided in this kit to the hydraulic preload adjuster. Attach the adjuster and the bracket to the engine cover as indicated in the figure.

### ⚠ WARNING!

Make sure that the hydraulic preload adjuster hose runs in soft bends. Also check that it does not come in contact with the exhaust pipe or any sharp edges.

**14**

Reattach the tool box, tools, lid, fuse box bracket, frame- and engine cover, CDI-box bracket, passenger foot peg and both side covers. Make sure that all removed parts are attached in the same way as they were before installation.

Make sure that all screws are tightened to the correct torque and that nothing fouls or restricts movement of the shock absorber when the suspension is fully compressed or extended.

