



Öhlins Racing AB, Box 722, S-194 27 Upplands Väsby, Sweden.
Phone +46 8 590 025 00. Fax +46 8 590 025 80.
www.ohlins.com

SU691 - Issued 2005 10 21

Mounting Instructions

Öhlins Shock Absorber SU691 for Suzuki RM 125 2006

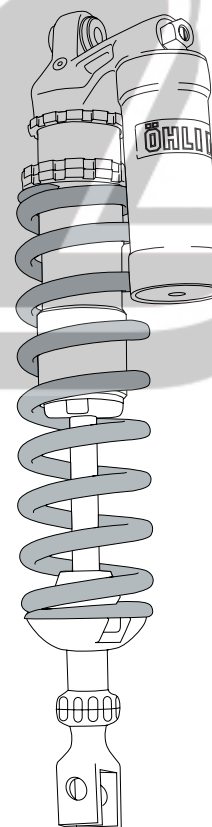

Kit Contents

Before installing this shock absorber, please check the contents of the kit listed below. If any part is missing, please contact your Öhlins dealer.

shock absorber 46PRXW	SU 691 (1)
spring clip	00629-21 (1)
c-spanner	00710-02 (1)
Öhlins stickers	00197-01 (2)
memo notes sticker	01180-01 (1)
Öhlins owner's manual	(1)

NOTE!

Spring not included. See the spring guide in this manual.

Öhlins Racing AB cannot be held responsible for any damage to the shock absorber, vehicle or injury to persons, if the instructions for fitting and maintenance are not followed exactly. Similarly, the warranty will become null and void if the instructions are not adhered to.

In this manual

Safety precautions
Mounting instructions
Changing the spring
Before riding
Set-up data
Adjustments
Spring guide

SAFETY PRECAUTIONS

Read this manual carefully!

Pay special attention to statements preceded by the following notations:



The Safety alert symbol means: Attention! Your safety is involved!

WARNING

Failure to follow these warning instructions may result in **severe or fatal injury** to anyone working with, inspecting or using this shock absorber, or to bystanders.

CAUTION!

Caution indicates that special precautions must be taken to avoid damage to the shock absorber.

NOTE!

Indicates information that is of importance regarding mounting procedures.

NOTE!

Öhlins products are subject to continuous improvement and development. Therefore, although these instructions include the most up-to-date information available at the time of printing, there may be minor differences between your shock absorber and this manual. Please consult your Öhlins dealer if you have any questions regarding the contents of this manual.

NOTE!

During storage and transportation, especially at high ambient temperature, the oil and grease used for assembling may run out inside the packing and damage the expanded polystyrene packing material. This is not unusual and is in no way detrimental to the shock absorber.

WARNING!

1. **Installing a shock absorber, that is not approved by the vehicle manufacturer, may affect the vehicle's stability.** Öhlins Racing AB cannot be held responsible for any personal injury or damage that may occur after fitting the shock absorber. Contact an Öhlins dealer for advice.

2. The **vehicle service manual must be referred to** when installing this shock absorber.

3. Please study and make certain you fully understand the mounting instructions and the owner's manual before handling this shock absorber. If you have any questions regarding proper installation procedures, contact an Öhlins dealer.



SPRING GUIDE

Brand	Rider's weight Kg/pounds	Spring	Spring rate N/mm
Suzuki RM 85	35/77	698-05	42
	40/88	698-06	44
	45/99	698-07	46
	50/110	698-08	48
	55/121	698-09	50
Suzuki RM 125	65/143	596-06	44
	70/154	596-07	46
	75/165	596-08	48
	80/176	596-09	50
	85/187	596-10	52
Suzuki RM-Z 250	65/143	596-05	42
	70/154	596-06	44
	75/165	596-07	46
	80/176	596-08	48
	85/187	596-09	50
	90/198	596-10	52
Suzuki RM 250	65/143	596-06	44
	70/154	596-07	46
	75/165	596-08	48
	80/176	596-09	50
	85/187	596-10	52
	90/198	596-11	54

ADJUSTMENTS

The Öhlins shock absorber **SU691** features the following adjusters:

Spring preload adjustment

Turn the rings on the shock absorber body using the C-spanner provided in this kit. Turn clockwise for harder adjustment, turn counter-clockwise to release the preload.

Compression damping adjustment

Adjustments are made on top of the reservoir. Low speed adjustment: Slotted centre screw. High speed adjustment: Hexagon screw.

Rebound damping adjustment

Adjust by turning the wheel on the piston shaft above the end bracket.

NOTE!

When delivered, the Öhlins shock absorber is dialed to recommended settings for the specific brand and make of the motorcycle. If you have changed the setting, reset according to the following description:

Turn adjusters have a normal right hand thread. Turn the damping adjusters clockwise to fully closed (position zero [0]). Turn counter clockwise to open and count the clicks until you reach the recommended number of clicks. See setup data in this manual.

CAUTION!

Do not use too much force, delicate sealing surfaces can be damaged.

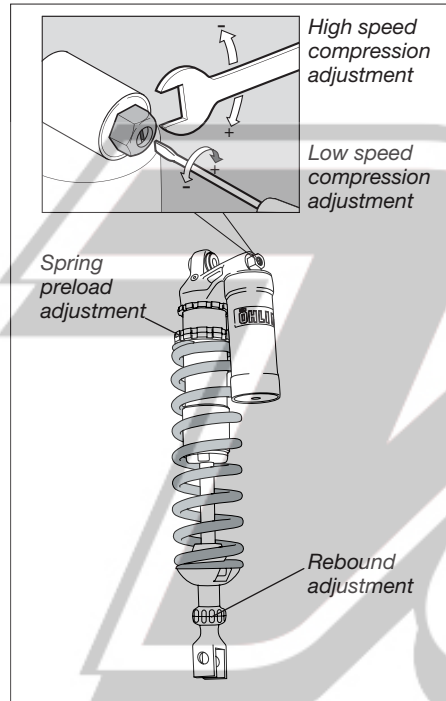

NOTE!

Read more about compression, rebound and spring pre-load in your Öhlins Owner's manual.

MOUNTING INSTRUCTIONS

Step 1 - Assembly of Öhlins Shock Absorber with spring

⚠ WARNING!

1. It is advisable to have an Öhlins dealer install the shock absorber.
2. Follow the instructions in the vehicle service manual when changing the shock absorber.
3. When working on a raised vehicle, make sure that it is securely supported to prevent it from tipping.

1

Make sure that all components listed on the front page of this manual under "Kit contents" are included.

2

Measure the free length of the spring (A).

3

Fit the spring clip, turn the shock absorber so the spring rests against the spring platform and turn the rings (lock nut and spring platform) so they touch the upper surface of the spring.

Setting the spring pre-load

With a C-spanner, turn the upper spring platform approximately **6 turns (10 mm)** clockwise to pre-load the spring before fitting the shock absorber to the motorcycle.

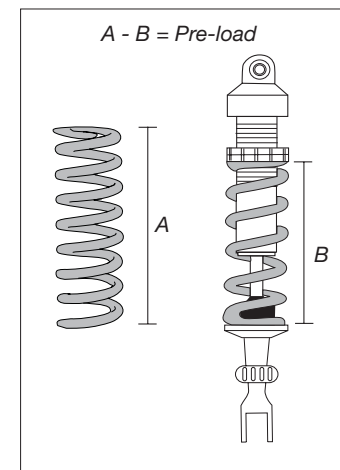
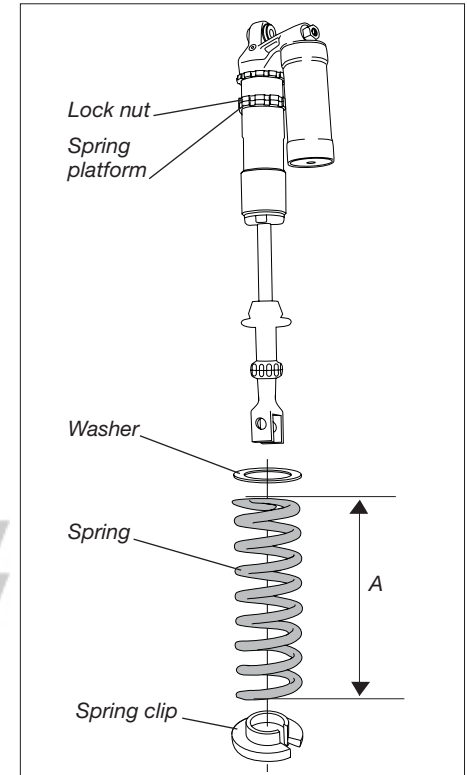

CHANGING THE SPRING

1

To remove the original spring you must first loosen the spring pre-load by turning the upper spring platform counter clockwise with a C-spanner.

2

Remove the spring clip and then the original spring.

3

Change spring and set the new spring pre-load according to the section above.

MOUNTING INSTRUCTIONS

Step 2 - Installing the shock absorber

▲ WARNING!

1. It is advisable to have an Öhlins dealer install the shock absorber.
2. Follow the instructions in the vehicle service manual when changing the shock absorber.
3. When working on a raised vehicle, make sure that it is securely supported to prevent it from tipping.

1

Put the motorcycle on a workstand to raise the rear wheel off the ground.

2

Remove the seat by loosening the rear attachment screws.

3

Loosen the rear frame and the hose clamp from the air box. Remove the whole unit with air box and silencer.

4

Loosen the lower and the upper attachment of the original shock absorber and remove it.

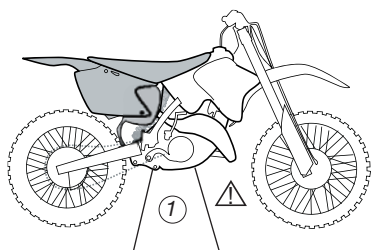

5

Fit the Öhlins shock absorber in the same way as the original unit. Fasten it with the two original bolts.

NOTE!

Put the motorcycle back on the floor before tightening the bolts. Make sure the vehicle is secure and will not fall over. You may need an assistant for this.

6

Place the air box, rear frame and seat back in position and fasten them.

NOTE!

Make sure that all bolts are tightened to the correct torque and that nothing fouls or restricts movement of the shock absorber when the suspension is being fully compressed or extended.

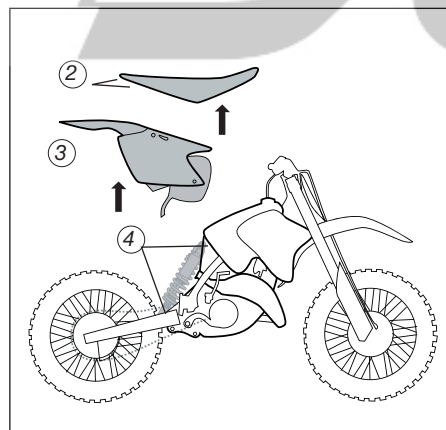

BEFORE RIDING

IMPORTANT NOTICE!

Before riding your bike, check sag and ride height according to your Öhlins Owner's manual.

To get the most out of your suspension component it is of great importance to make proper settings and to use the correct spring for your weight - **full riding equipment on!**

We recommend you to read your Öhlins Owner's manual carefully to understand the different effects of the different settings.

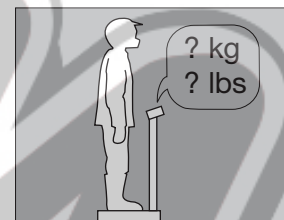
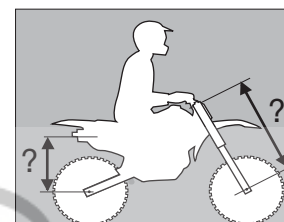

SET-UP DATA

NOTE!

Read more about compression and rebound in your Öhlins Owner's manual.

NOTE!

If your measured sag and ride height differ from this set-up data, change the preload according to the section "Adjustments" in this manual.

If, after changing the preload, ride height is still higher than recommended, softer spring/springs must be used. If ride height is lower than recommended, harder spring/springs must be used. Contact your Öhlins dealer for advice.

Rebound adjustment	22 clicks
Low speed compression	15 clicks
High speed compression	1.5 turns
Free sag, rear	30 ± 5 mm
Free sag, front	30 ± 5 mm
Ride height, rear	102 - 107 mm
Ride height, front	80 ± 5 mm

Shock absorber length	479.5 mm
Stroke	127.5 mm