

👁 Note!

Before installing this product, check the contents of the kit. If anything is missing, please contact an Öhlins dealer.

Kit Contents

Description	Part No	Pcs
Shock absorber	HO428	1
Sticker Öhlins	00192-01	2
Sticker Öhlins	01185-01	1
Sticker Öhlins	01185-04	1
C-spanner	00710-02	1
Owner's manual	07241-02	1

👁 Note!

Please note that this image is a general representation of the product and may differ slightly from your product.

👁 Note!

Please note that during storage and transportation, especially at high ambient temperature, some of the oil and grease used for assembling may leak and stain the packaging. This is in no way detrimental to the product, wipe off the excessive oil/grease with a cloth.

⚠ Warning!

Before installing this product, read the Öhlins Owner's Manual. The shock absorber is an important part of your vehicle and will affect the stability.

Shock Absorber for Honda CB 650 F/ CBR 650 F

HO428

Mounting Instructions

MOUNTING INSTRUCTIONS

⚠ Warning!

It is advisable to have an Öhlins dealer install the shock absorber.

⚠ Warning!

If working on a raised vehicle, ensure it is securely supported so that it will not tip over.

👁 Note!

Before mounting this product clean the vehicle thoroughly.

👁 Note!

When working on this product, always see the Vehicle Service Manual for vehicle specific procedures and important data.

Index

CB650F.....	2-5
CBR650F.....	6-11

CB650F

1

Put the motorcycle on work stand so that rear wheel barely touch the ground. Make sure the motorcycle is in a stable position.

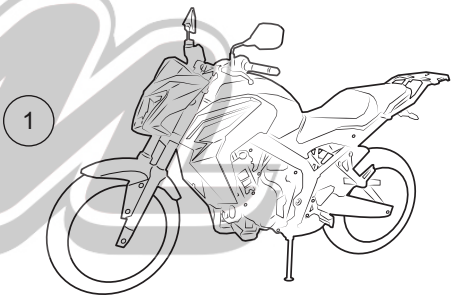

2

Open the seat and remove it.

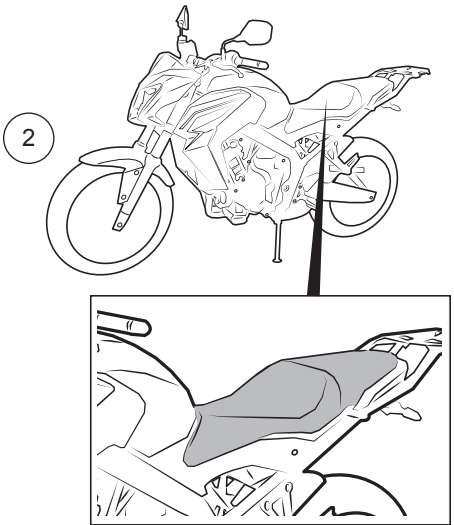

MOUNTING INSTRUCTIONS

- 3**
Remove the center fairing on both sides by loosening a screw then loosening plastic clip and unlock the clip inside as indicated by the arrow.

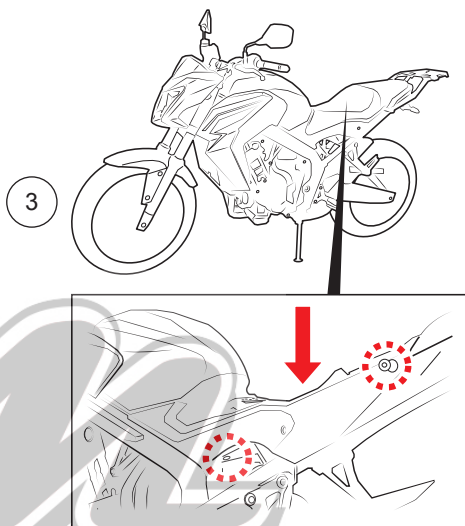

- 4**
Remove the outside front fairing on both sides by loosening the three screws.

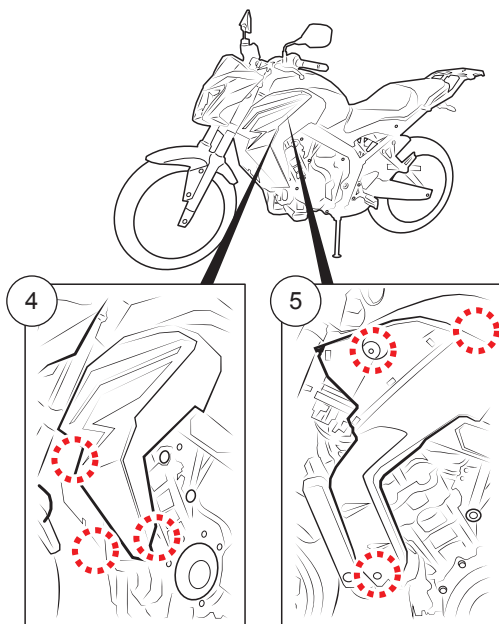

- 5**
Remove the inside front fairing on both sides by loosening the three screws.

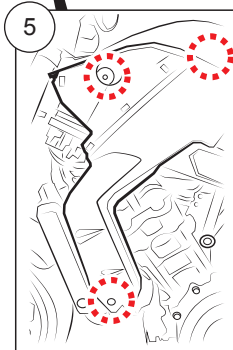

MOUNTING INSTRUCTIONS

6

Loosen the bolt and lift the fuel tank up in the order to access upper bolt of standard shock absorber.

6

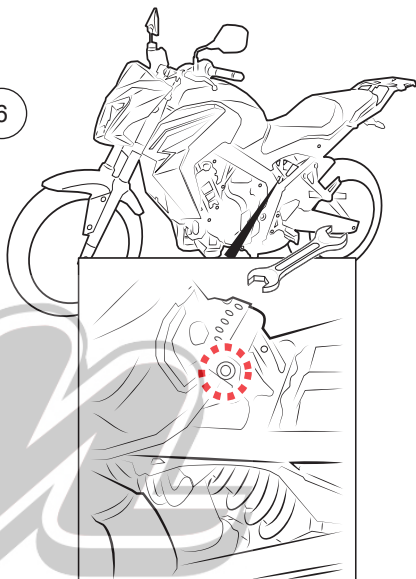

7

Remove the chain guard by loosening the four screws.

7

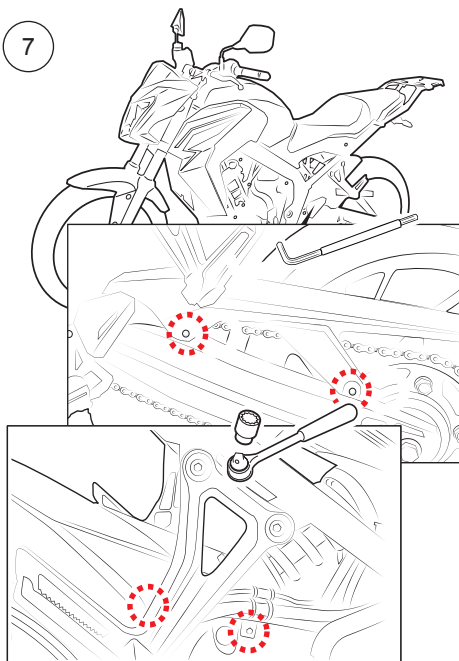

MOUNTING INSTRUCTIONS

8

Remove the standard shock by loosening the upper and the lower bolts.

8

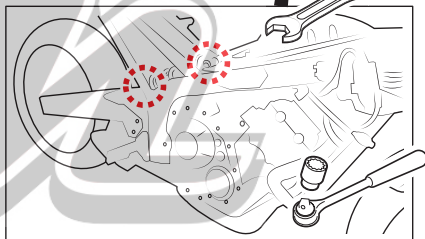
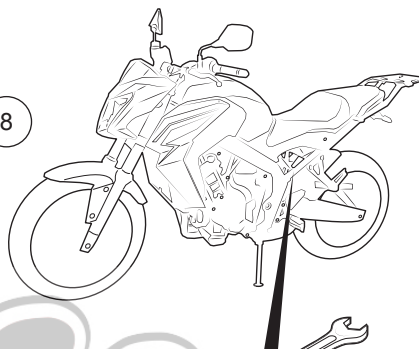

9

Install the Öhlins shock absorber with the cylinder head upward and the gas valve facing to the left.

Tighten the upper and the lower bolts.

Reverse all procedures.

9

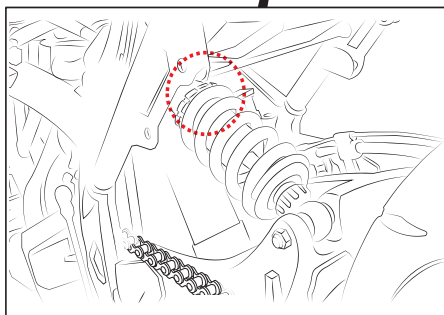
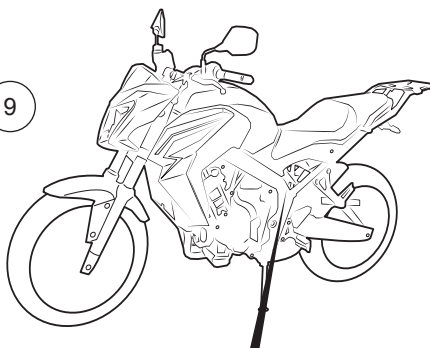

MOUNTING INSTRUCTIONS

CBR 650 F

1

1
Put the motorcycle on work stand so that rear wheel barely touch the ground. Make sure the motorcycle is in a stable position.

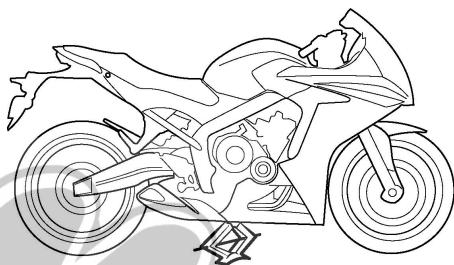

2

2
Open the seat and remove it.

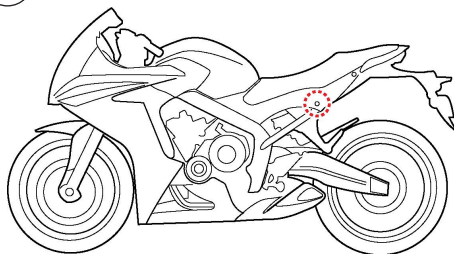

MOUNTING INSTRUCTIONS

3

3
Remove the center fairing on both sides by loosening the bolt (1), then unlock the plastic clip inside as indicated by arrow (2) and loosen the plastic clip (3).

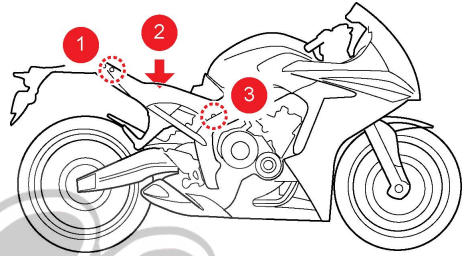

4

4
Release the front fairing on both sides by loosening the four bolts (1)(2)(3)(4).

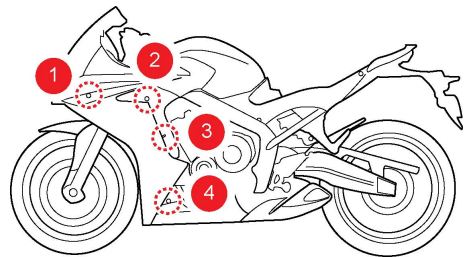

MOUNTING INSTRUCTIONS

5

5
Loosen the three bolts (1)(2)(3) and lift the fuel tank up in order to access the upper bolt of shock absorber.

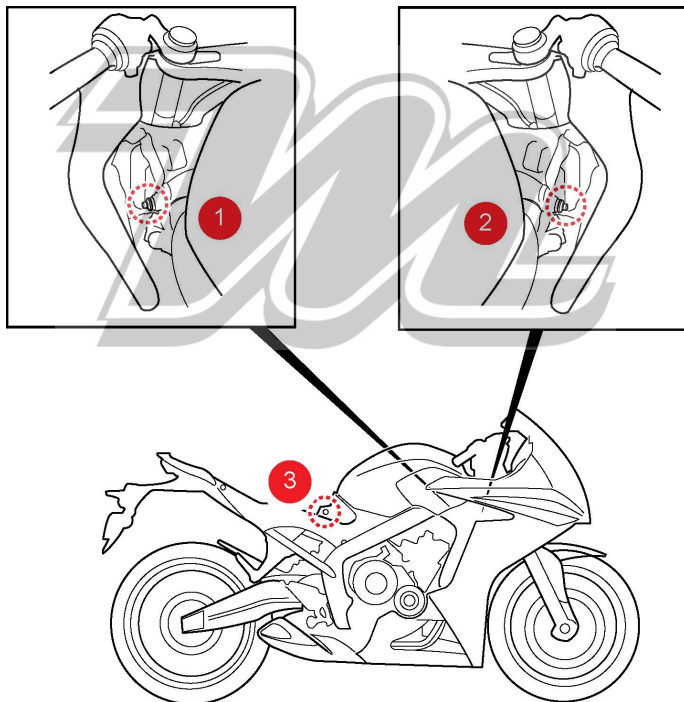

MOUNTING INSTRUCTIONS

6

Remove the chain guard by loosening the three bolts (1)(2)(3).

6

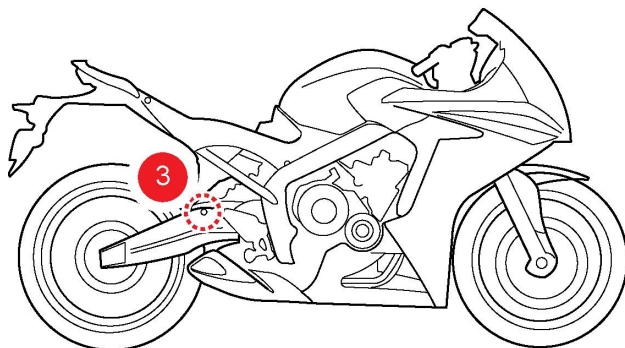
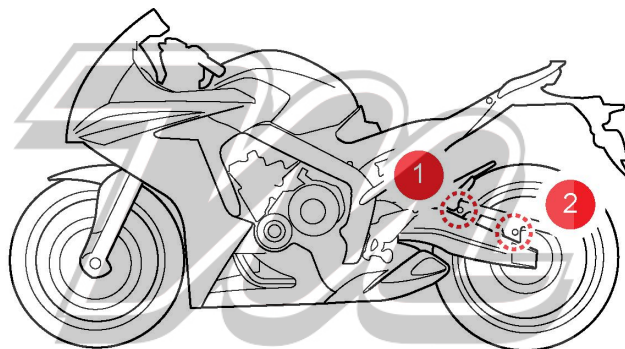

MOUNTING INSTRUCTIONS

7

Remove the standard shock absorber by loosening the upper (1) and the lower (2) bolts.

7

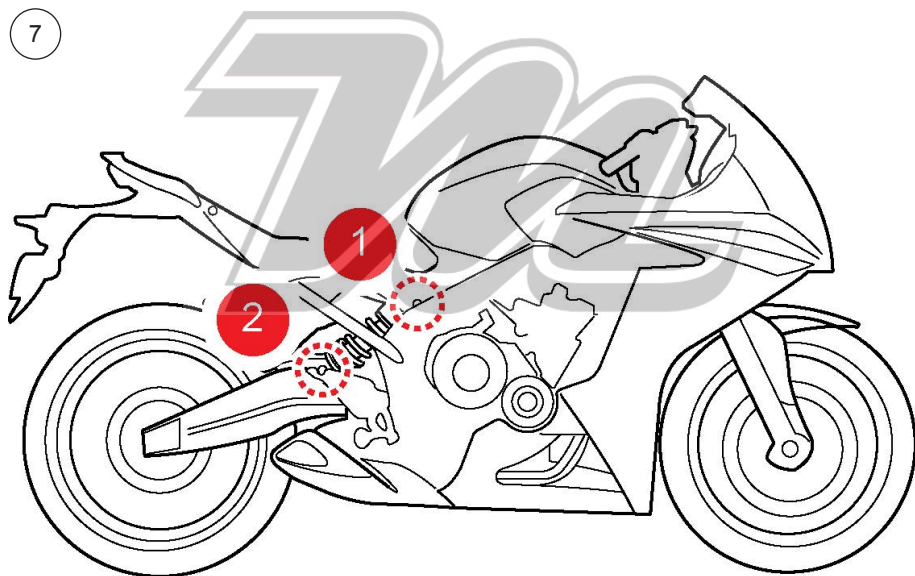

MOUNTING INSTRUCTIONS

8

8
Install the Öhlins shock absorber with the cylinder head upward and the gas valve facing to the left.

Tighten the upper and the lower bolts.

Reverse all procedures.

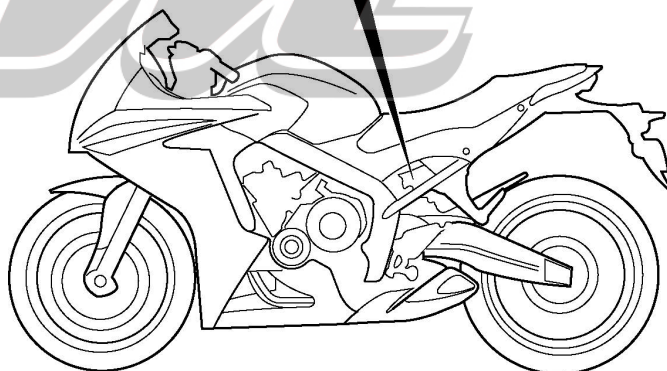
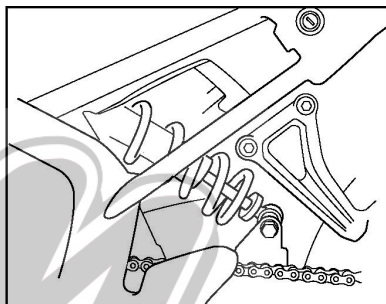

Note!

Lower the vehicle so that the suspension is slightly compressed before tightening the screws.

Caution!

Ensure that all screws are tightened to the correct torque and that nothing fouls or restricts movement of the shock absorber when the suspension is fully compressed or extended.

ADJUSTMENTS

⚠ Warning!

Before riding, always make sure that the basic settings made by Öhlins are according to recommended Set-up Data. Read about adjustments and setting up in the Öhlins Owner's Manual before you make any adjustments. Contact an Öhlins dealer if you have any questions about setting up.

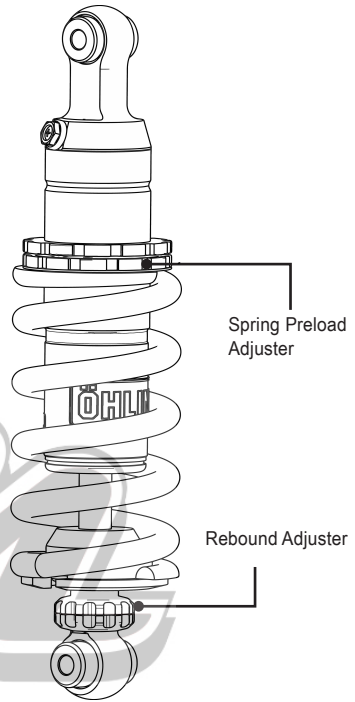

SET-UP DATA

Recommended set-up

Spring Preload 7 mm
Rebound Adjuster 16 Clicks

Shock absorber data

Length 331 mm
Stroke 49 mm

Spring

Part No 60016-69
Free spring length 170 mm

👁 Öhlins products are subject to continuous improvement and development, therefore, although these instructions include the most up-to-date information available at the time of printing, minor updates may occur.

To find the latest information contact an Öhlins distributor. Please contact Öhlins if you have any questions regarding the contents in this document.

Part no. MI_HO428_EN_0
Issued 2014-07-17

© Öhlins Asia Co. Ltd. All rights reserved. Any reprinting or unauthorized use without the written permission of Öhlins Racing AB is prohibited.

Öhlins Asia Co. Ltd
700/937 Moo5, Tambol Nongkhaga,
Amphur Phantong, Chonburi Province
20160 Thailand



www.ohlins.com