



Installation instructions

Akrapovič Exhaust Systems
Slip-On Street Legal, Slip-On Open
and **Slip-On Megaphone**
for the
YAMAHA YZF R6 2010



502590

Congratulations on purchasing an Akrapovič exhaust system. Please read the entire installation manual prior to undertaking any activities related to installation of your new Akrapovič exhaust system. In case you do not fully understand the manual or any of its parts, please contact your authorized dealer!

This product should be installed by someone with sufficient knowledge of exhaust systems and their installation, and appropriate hand or power tools. If you are not qualified for this work, please utilize a certified mechanic for installation. By installing Your Akrapovič exhaust system, you indicate that you have read the installation manual in its entirety and you agree with the terms stated herein.

It is your responsibility to follow all installation instruction guidelines supplied with the Akrapovič exhaust system and undertake all necessary safety precautions. Akrapovič d.d. assumes no responsibility for damages occurring from misuse, abuse, improper installation, improper operation, lack of responsible care, or all previously stated reasons resulting from incompatibility with other manufacturer's products and/or systems.

IMPORTANT INFORMATION

Exclusion of Certain Liability

1. The manufacturer, importer or dealer shall not be liable for any incidental damage including personal injury or any other damages caused by improper installation or operation of the Akrapovič exhaust system. When installing the Akrapovič exhaust system be careful that the exhaust system does not touch other parts sensitive to high temperature.
2. Akrapovič makes no representation or warranties with regard to damage caused by the improper installation, use and maintenance of the Akrapovič exhaust system. The warranty is limited to defects recognized by our technical department and due to normal use, and excludes items subject to normal wear (gaskets and damping wool). The guarantee is void in case of accident, modification, improper or competition use.
3. Do not attempt to install the Akrapovič exhaust system on a vehicle model for which it was not made or tested by Akrapovič.
4. When the exhaust system gets very hot during operation, be careful not to burn yourself on the exhaust system or parts which are in direct contact with it, even when the engine is not running. Also protect other people, especially children, from the injuries mentioned above.
5. In some cases Akrapovič exhaust system kits contain chemical products (ceramic anti-seizing grease; bolt sealant). Handle with care, do not inhale or swallow. Avoid excessive contact with skin, eyes or mucous membranes. Keep out of reach of children.
6. Technical specifications of Akrapovič exhaust systems and related products are subject to change without notice.
7. Before removing the original exhaust system from your vehicle, please compare the parts you received with the list of materials provided in the installation manual in order to assure that you have all the parts necessary for the installation of your new Akrapovič exhaust system.
8. Although this manual consists of instructions for installation in written form, as well as photographs and pictures representing individual steps of the installation, please note that the photographs and pictures are symbolic and are intended for representation of general overview only. The photographs and pictures contained herein should serve as a guideline only and actual installation of the exhaust system may not correspond with the photographs and pictures entirely.
9. The process of uninstalling the original exhaust system may vary depending on the existing exhaust system. Please follow the original exhaust system manufacturer's instructions for uninstalling the original exhaust system.

Trademarks

The Akrapovič Exhaust System Technology logo is a registered trademark of Akrapovič d.d.

Akrapovič website

Information about Akrapovič exhaust systems and related products is available on the Akrapovič website at: <http://www.akrapovic.com/>

Copyright

No part of the Akrapovič exhaust system or its documentation may be reproduced or distributed in any form or by any means without the prior written authorization of the Akrapovič company.

© Akrapovič, d.d. All rights reserved.

Symbols

The following symbols are used throughout these installation instructions:



TOOLS REQUIRED



TIGHTENING TORQUE



INSTALLATION TIP



CAUTION OR WARNING



USE BOLT SEALANT; Apply 3 to 4 small drops of bolt sealant onto the cleaned and degreased threads before tightening the bolts. **WARNING! Avoid contact with skin, eyes and mucous membranes. Do not inhale fumes. Keep out of reach of children.**



USE ANTI-SEIZE LEAD-FREE COPPER PASTE (black tube); Provides trouble-free and long-lasting protection against seizing, corrosion and rusting of bolts, threaded ends, nuts, joints, etc. Also protects against vibration, wear and impact. **WARNING! Avoid eye contact. Avoid excessive skin contact. Keep out of reach of children.**



USE ANTI-SEIZING GREASE (white tube); Prevents seizing, corrosion and excessive wear between the titanium components of your exhaust system. **WARNING! Avoid eye contact. Avoid excessive skin contact. Keep out of reach of children.**



T-handle 5 mm three hexagon wrench
T-handle 4 mm three hexagon wrench
T-handle 3 mm three hexagon wrench
T-handle 13mm wrench
T-handle 12mm wrench
T-handle 8mm wrench
T-handle swivelling 8mm wrench
Combination 10 mm wrench



BEFORE INSTALLING, CHECK SCHEMATIC OF THE EXHAUST SYSTEM!



IF ANY ITEMS IN THE AKRAPOVIČ EXHAUST SYSTEM PACKAGE ARE MISSING, PLEASE CONTACT YOUR AUTHORIZED DEALER. KEEP THE SCHEMATIC FOR FUTURE REFERENCE.



THESE INSTALLATION INSTRUCTIONS MUST BE READ CAREFULLY IN ORDER TO ENSURE PROPER INSTALLATION AND OPERATION OF THE AKRAPOVIČ EXHAUST SYSTEM.



THE EXHAUST SYSTEM CAN BE EXTREMELY HOT. ALLOW THE EXHAUST AND ENGINE TO COOL DOWN BEFORE BEGINNING INSTALLATION.



WE ADVISE YOU TO LEAVE INSTALLATION TO A QUALIFIED SERVICEMAN. IMPROPER INSTALLATION MAY RESULT IN A SHORTER LIFETIME OF THE EXHAUST SYSTEM AND/OR DAMAGE TO THE VEHICLE.

REMOVAL OF STOCK EXHAUST SYSTEM:

1. Put the motorcycle on a side stand, we recommend a racing stand.
2. Unscrew the marked bolts and remove the stock heatshield (**Figure 1**).



Figure 1

3. Unscrew the marked nuts and remove the exhaust valve cables off the cable bracket (**Figure 2**).
! WARNING: make sure not to damage any part of the motorcycle during this process!

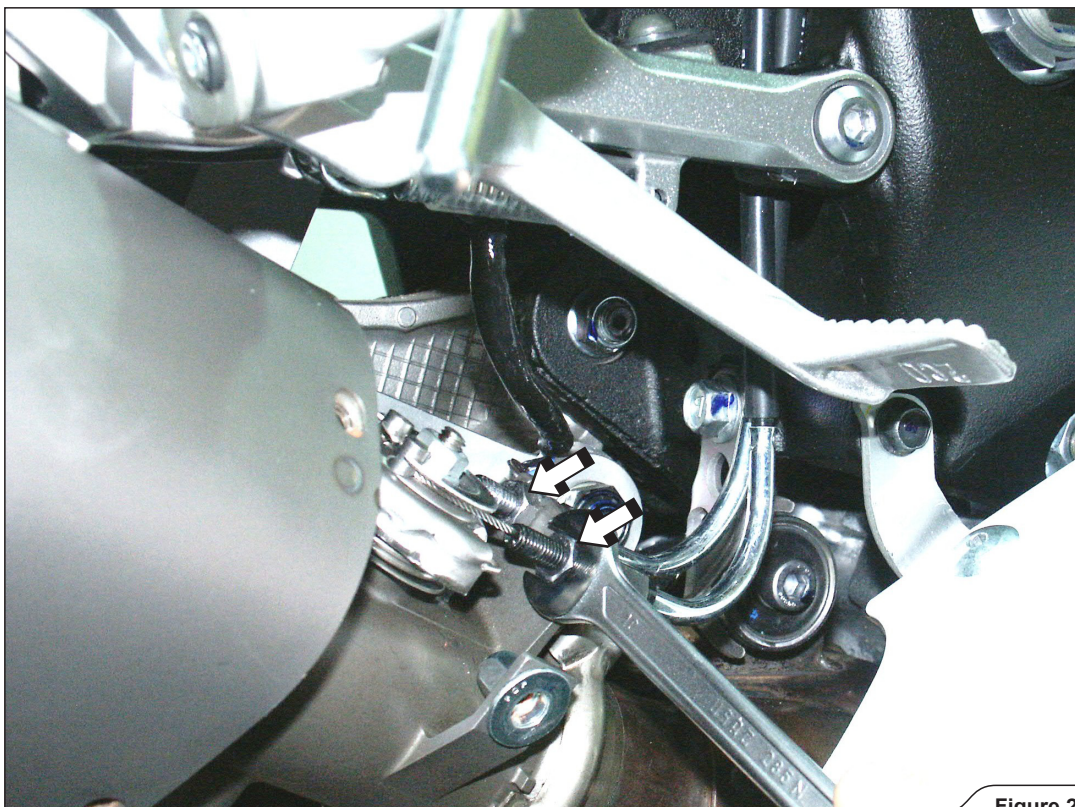

Figure 2

4. For Slip-On Open and Slip-On Megaphone only: unscrew the marked cable bracket (Figure 3).

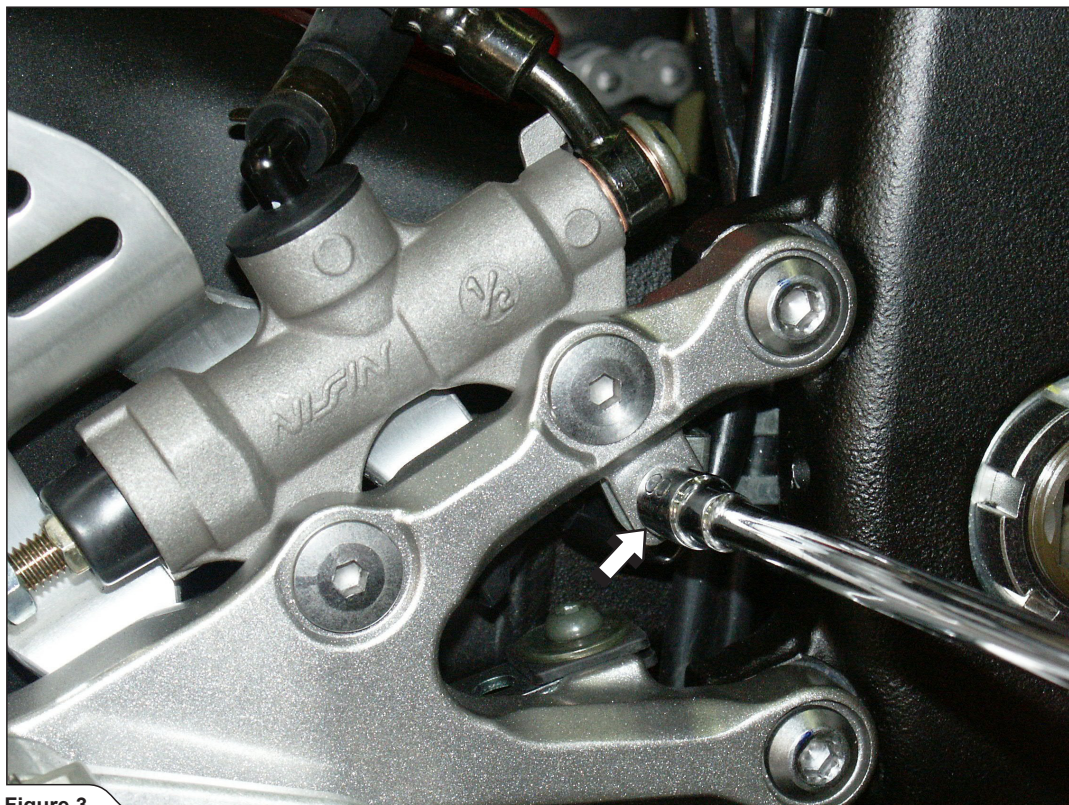

Figure 3

5. For Slip-On Open and Slip-On Megaphone only: unscrew the exhaust valve servo motor, remove the cables off the servo wheel and tighten the servo back on (Figure 4, 5, 6). Remove the exhaust valve cables off the motorcycle (Figure 7).
! WARNING: do not turn the the servo motor wheel with force or the servo motor could be damaged!
! WARNING: do not disconnect the servo's electrical connector or remove the servo motor off the vehicle!



Figure 4



Figure 5



Figure 6

! **WARNING:** make sure not to scratch or damage any part of the motorcycle during removal of the cables!

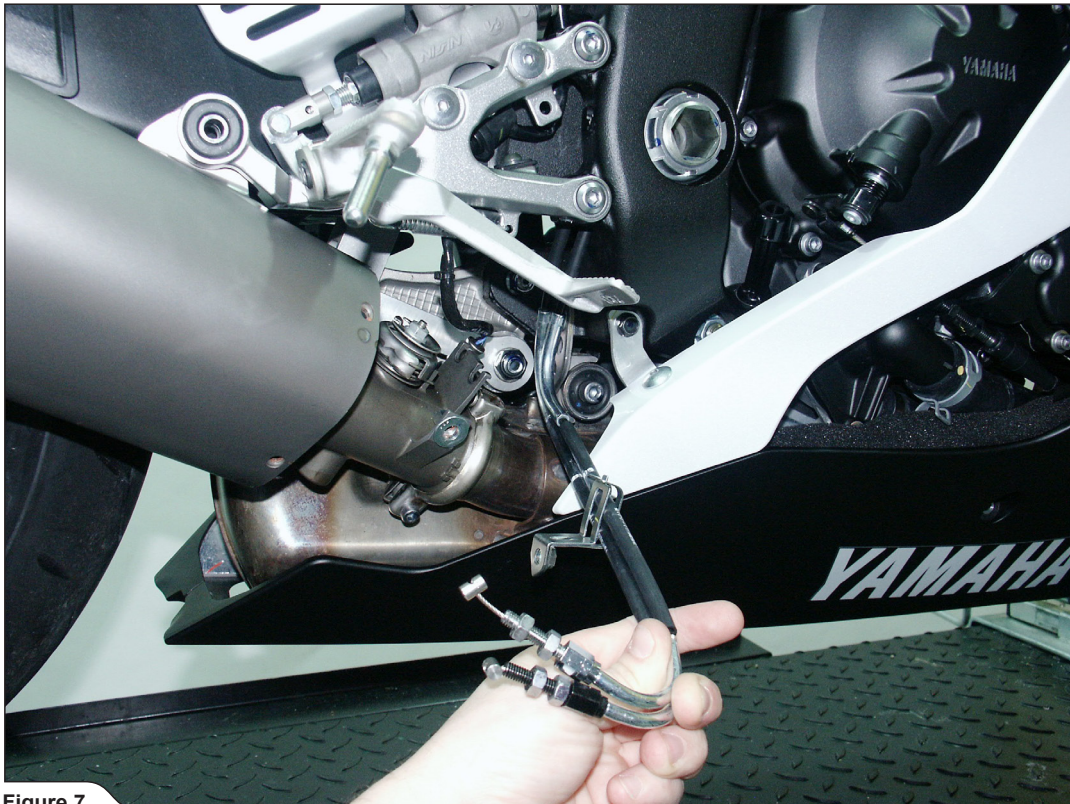

Figure 7

6. Unscrew the marked clamp bolt and remove the muffler together with clamp and graphite gasket off the motorcycle (Figure 8).

! **WARNING:** make sure not to scratch or damage any part of the motorcycle during this process!



Figure 8

INSTALLATION OF THE AKRAPOVIČ SLIP-ON SREET LEGAL EXHAUST SYSTEM:

1. Correctly install the clamp onto the muffler inlet bush as shown (Figure 9).

! **WARNING:** use anti-seize copper paste on bolt threads of the clamp!



Figure 9

2. Slide the muffler onto the stock outlet and correctly attach the cables onto the cable bracket (the cable with black adjuster must be on top!). Adjust the lower adjuster as shown - 4.5mm between adjuster nuts (Figure 10).

! **WARNING:** be precise at adjusting the cables, or the exhaust valve won't work properly!

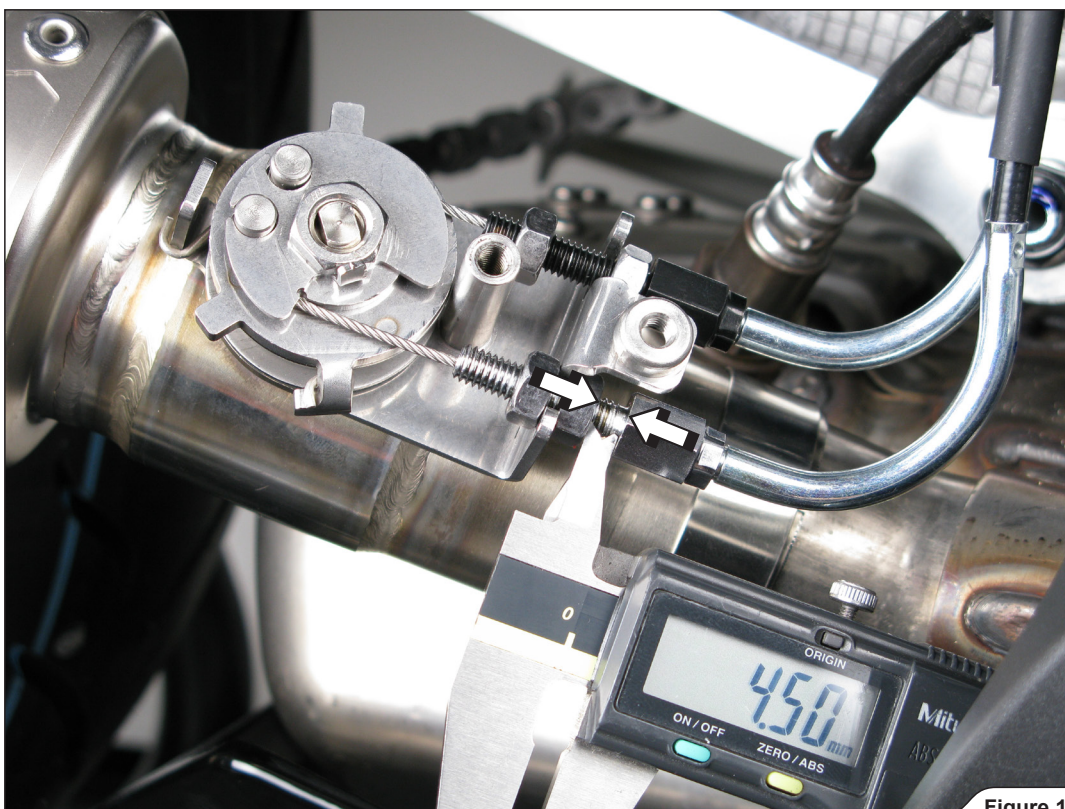

Figure 10

- Adjust the upper adjuster (black), until the distance between exhaust valve wheel stoppers is 10mm (Figure 11).
! WARNING: be precise at adjusting the cables, or the exhaust valve won't work properly!

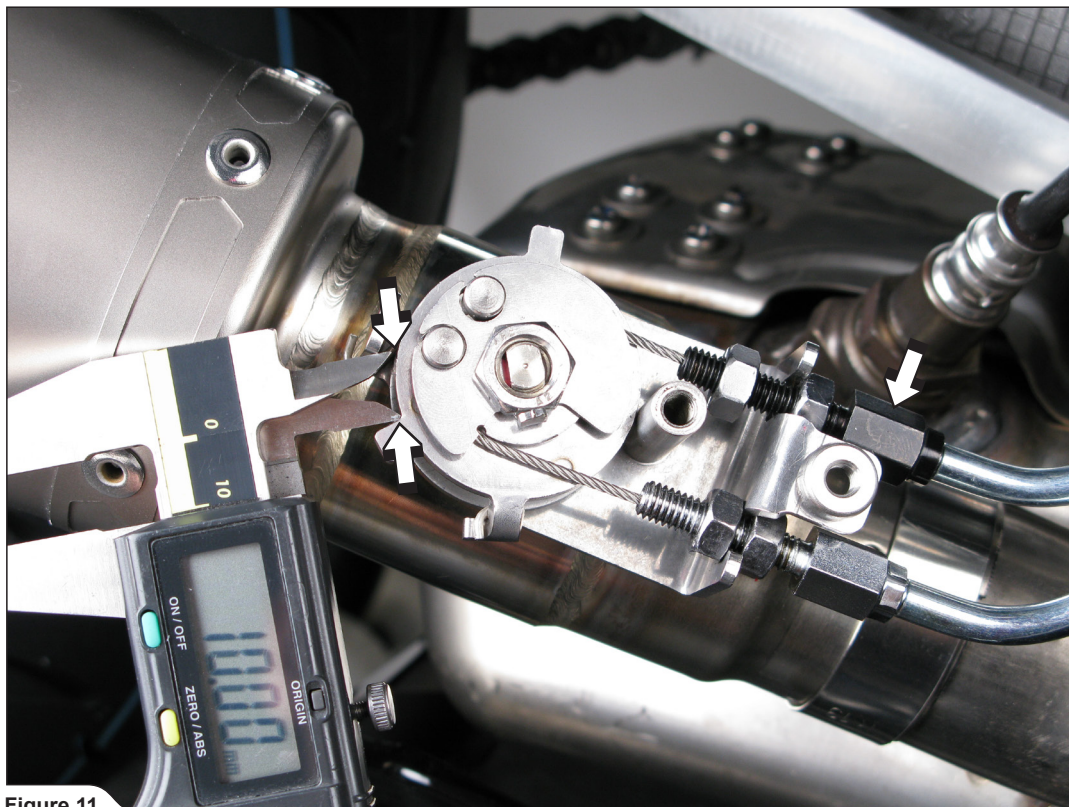

Figure 11

- Tighten the marked adjusters lock nuts to a specified torque (Figure 12).

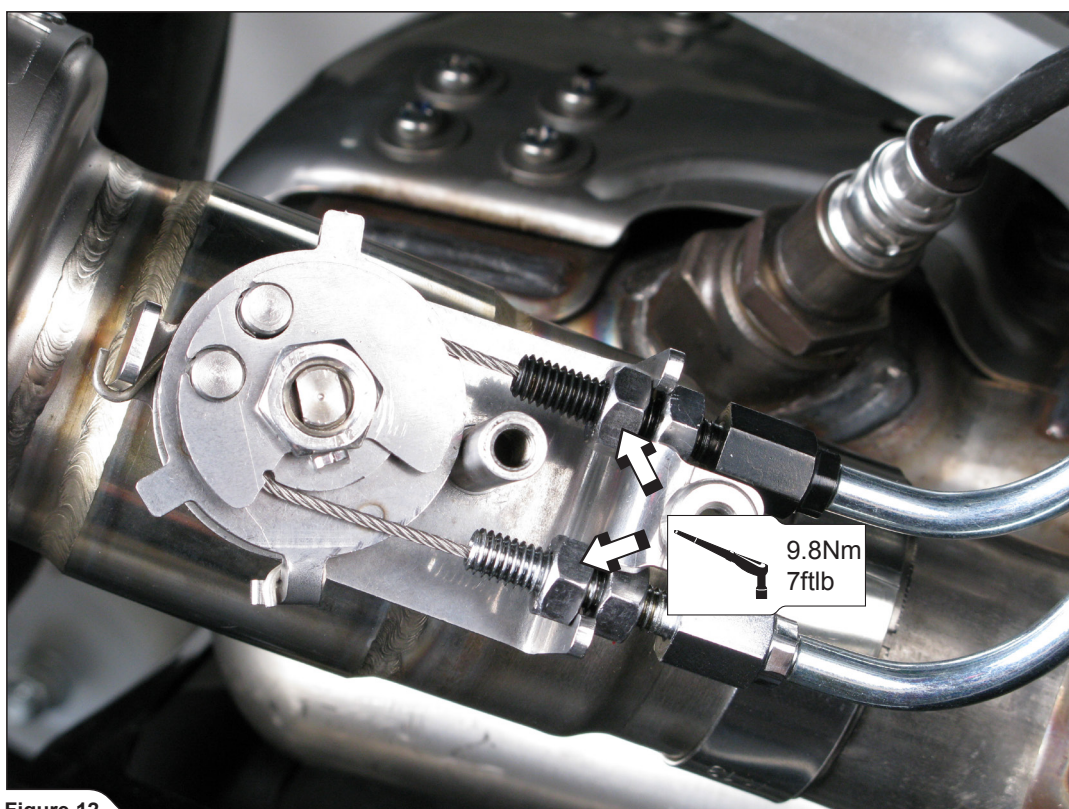

Figure 12

5. Assemble the carbon-fiber shield onto the exhaust valve, using Akrapovič M5 bolts and heat resistant washers (Figure 13).

! **WARNING:** heat resistant washers should be between carbon-fiber shield and shield brackets!

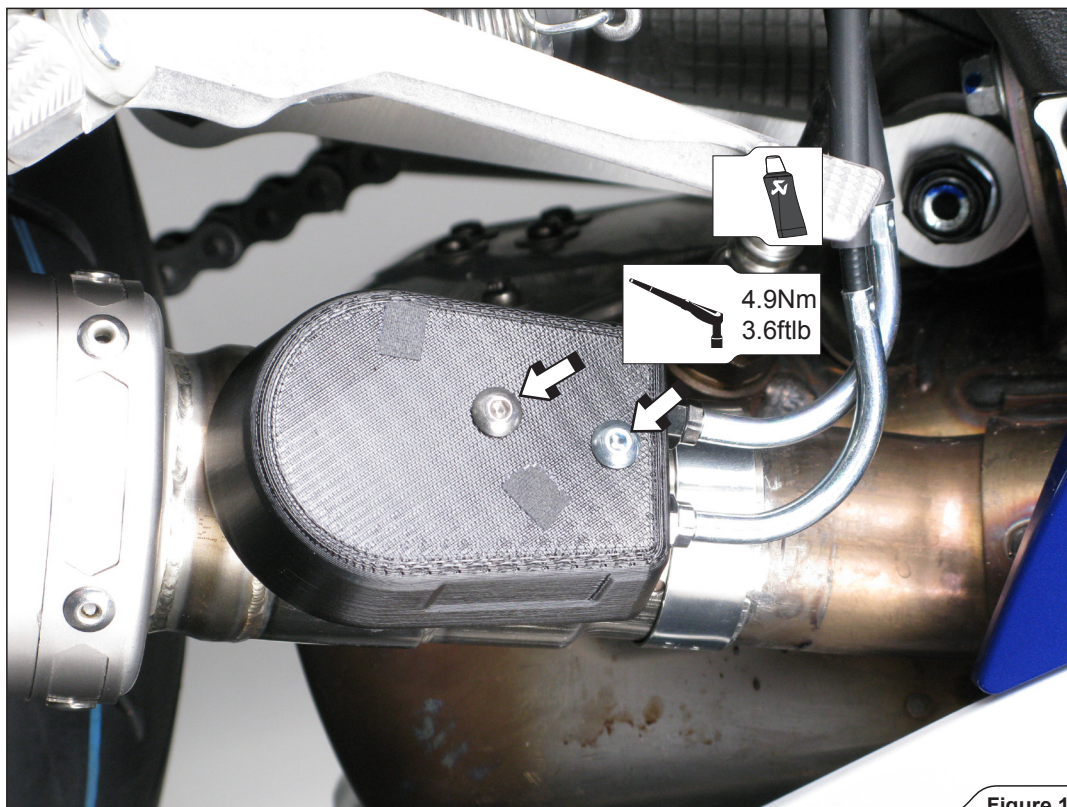

Figure 13

6. Align the muffler in respect to the motorcycle. Tighten the muffler bracket (using stock bolt with washer) and metal muffler inlet clamp (Figure 14).

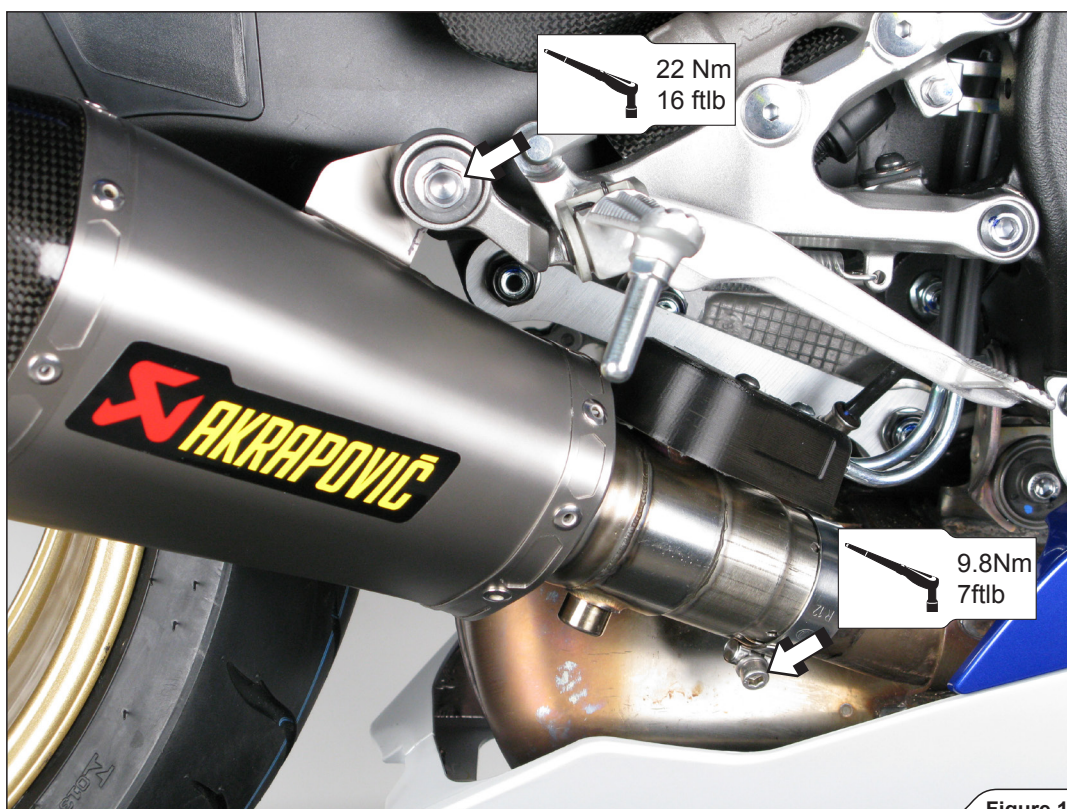

Figure 14

INSTALLATION OF THE AKRAPOVIČ SLIP-ON OPEN AND SLIP-ON MEGAPHONE EXHAUST SYSTEMS:

1. Correctly install the clamp onto the inlet bush as shown (Figure 15).
- ! **WARNING:** use anti-seize copper paste on bolt threads of the clamp!

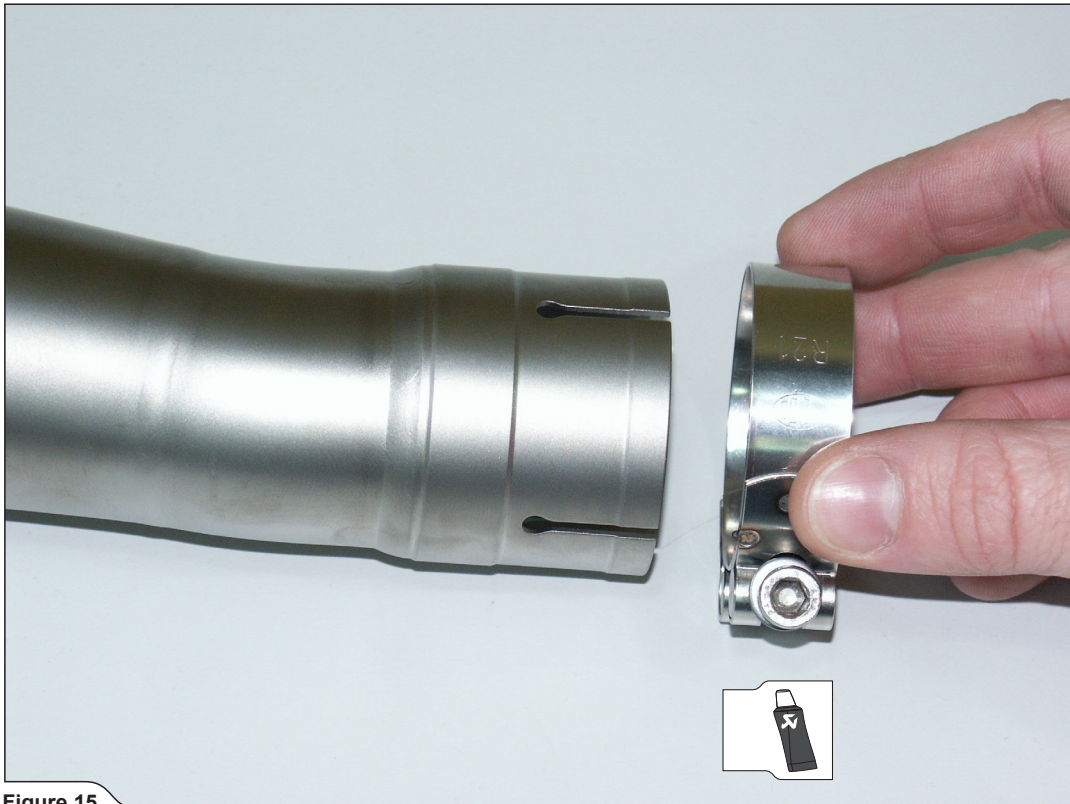

Figure 15

2. Position the muffler or megaphone correctly and slide it onto the outlet of the stock collector. Align the muffler or megaphone in respect to the motorcycle and tighten the bracket, using stock bolt and washer (Figure 16).

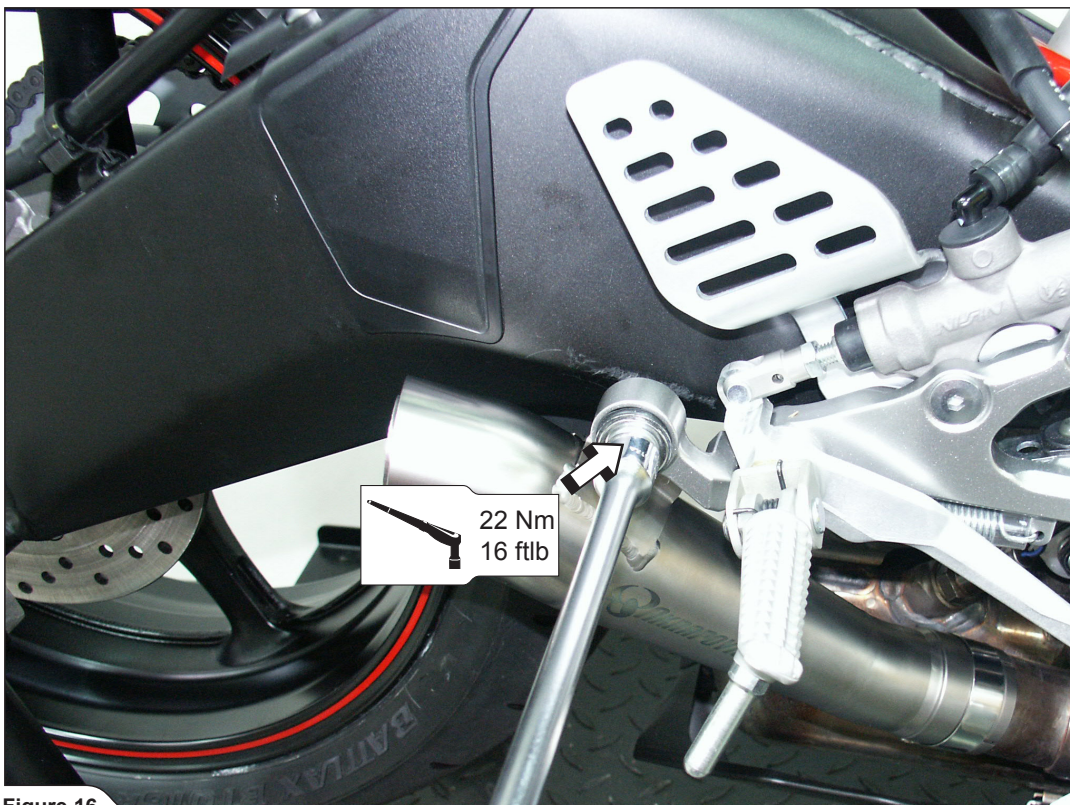

Figure 16

3. Tighten the metal megaphone inlet clamp to a specified torque (**Figure 17**).

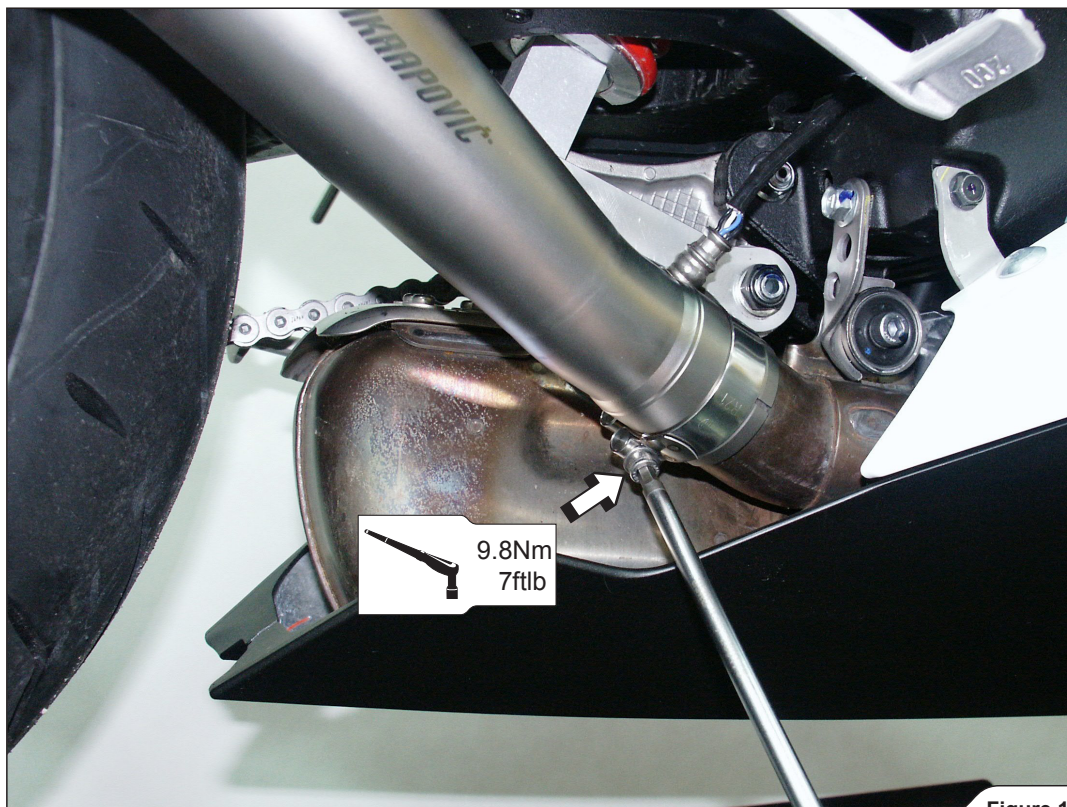

Figure 17

Final installation:

Clean grease spots:

- a. Muffler – use a soft cloth sprayed with a multi-purpose spray lubricant (WD-40 or equivalent).
- b. Megaphone – use a soft cloth sprayed with a multi-purpose spray lubricant (WD-40 or equivalent).

Cleaning will prevent spots from burning onto the surface. Do not use aggressive chemical cleaners, because they can damage the sticker.

- ! **WARNING: make sure all the bolts are sufficiently tightened. In case the exhaust system touches the cowling or other parts repeat the adjustment of the exhaust system or contact your authorized dealer.**
- ! **WARNING: check vehicle manufacturer manual for tightening torques (for dismantled stock parts)!**
- ! **IT IS NORMAL IF WHITE SMOKE COMES OUT OF THE MUFFLER ON FIRST OPERATION.**
- ! **DO NOT STAND BEHIND THE MUFFLER ON FIRST OPERATION.**
- ! **DO NOT USE AUTOMOTIVE WHEEL CLEANERS OR ANY CLEANING PRODUCTS WHICH CONTAIN ACIDIC ADDITIVES TO CLEAN AKRAPOVIĆ EXHAUST SYSTEMS.**

MAINTENANCE OF THE AKRAPOVIĆ EXHAUST SYSTEM

1. Clean the titanium exhaust components with a multi-purpose spray lubricant (WD-40 or equivalent), carbon fiber exhaust components with soft and dry cloth and stainless steel components with soft cloth sprayed with contact cleaner, then wipe with soft and dry cloth. A change in the color of the exhaust system is normal due to the high temperatures.
2. Periodically make sure all the bolts and springs are sufficiently tight.

Product code: S-Y6SO9-ASZ
S-Y6SO9T-ASZ

M-ASZ00202T STAINLESS STEEL MUFFLER
WITH TITANIUM OUTER SLEEVE

M-ASZ00205T FULL TITANIUM MUFFLER

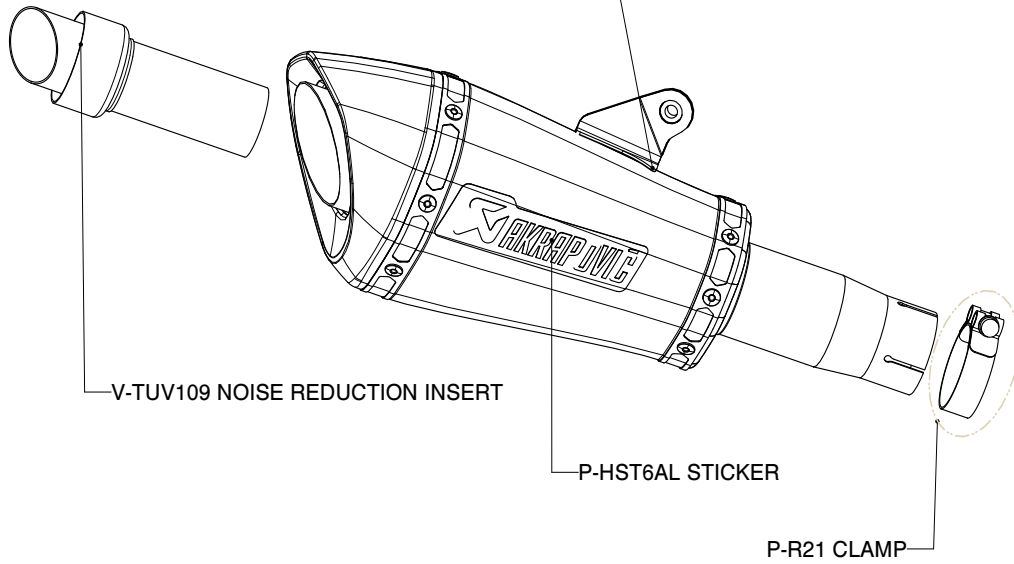

Yamaha YZF R6, SLIP ON exhaust system - street legal: 2010

Product code: S-Y6SO9-HASZ
S-Y6SO9T-HASZ

M-HAS1Z00202T STAINLESS STEEL MUFFLER
WITH TITANIUM OUTER SLEEVE

M-HAS1Z00205T FULL TITANIUM MUFFLER

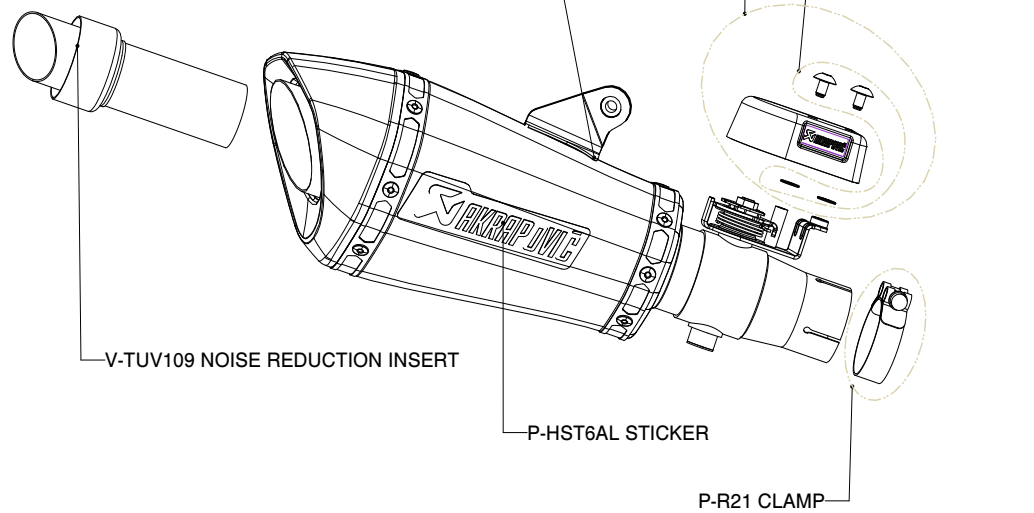

Yamaha YZF R6, Complete exhaust system / EVOLUTION LINE tube set with Street legal SLIP on Mufflers, Model year: 2010

Product code: S-Y6E8-ASZ/1

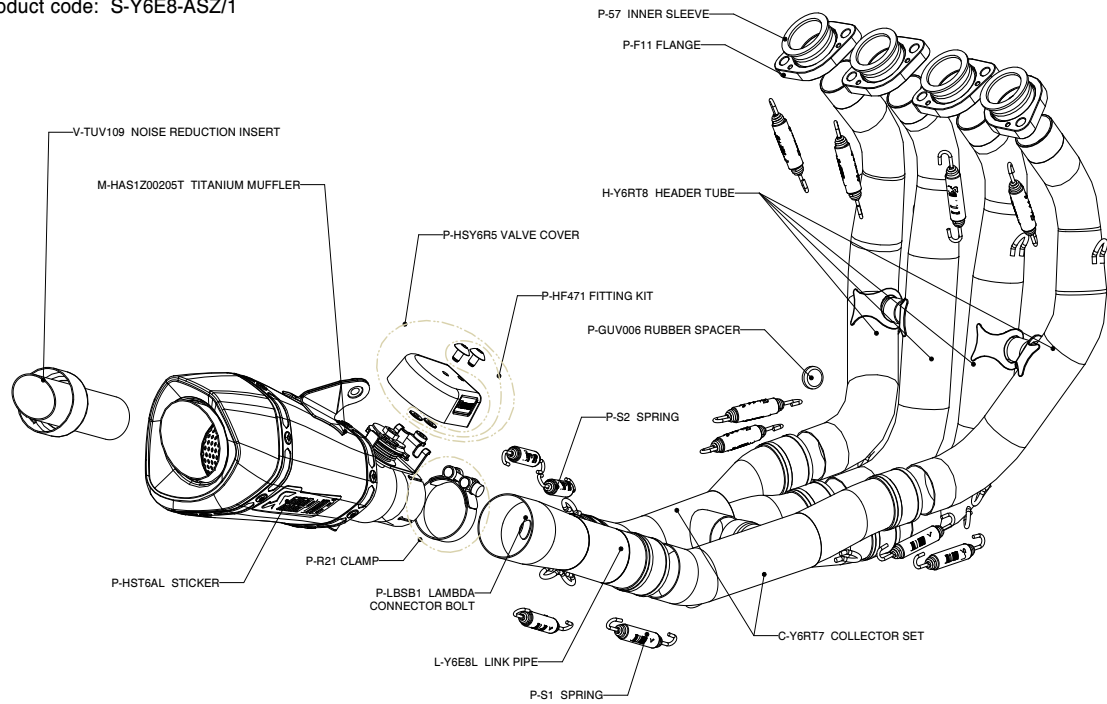

WARNING! THE SLIP ON HOMOLOGATION IS NOT VALID IN COMBINATION WITH EVOLUTION TUBE SET

