

Installation instructions:



AKRAPOVIČ RACING, RACING1, RACING2 & EVOLUTION, EVOLUTION1, EVOLUTION2 EXHAUST SYSTEMS

for the SUZUKI GSX-R600, GSX-R750 (2008 - 2009)

Congratulations on purchasing an Akrapovič exhaust system. Please read these installation instructions carefully. If you have any trouble installing the system please contact your authorized dealer!

IMPORTANT INFORMATION

Exclusion of Certain Liability

1. The manufacturer, importer or dealer shall not be liable for any incidental damage including personal injury or any other damages caused by improper installation or operation of the Akrapovič exhaust system. When installing the Akrapovič exhaust system be careful that the exhaust system does not touch other parts sensitive to high temperature.
2. Akrapovič makes no representation or warranties with regard to damage caused by the improper installation, use and maintenance of the Akrapovič exhaust system. The warranty is limited to defects recognized by our technical department and to normal use, and excludes items subject to normal wear (gaskets and damping wool). The guarantee is void in case of accident, modification, improper or competition use.
3. Do not attempt to install the Akrapovič exhaust system on a motorcycle for which it was not made or tested by Akrapovič.
4. When the exhaust system gets very hot during operation, be careful not to burn yourself on the exhaust system or parts which are in direct contact with it, even when the motor is not running. Also protect other people, especially children, from the injuries mentioned above.
5. In some cases Akrapovič exhaust system kits contain chemical products (ceramic anti-seizing grease; bolt sealant). Handle with care, do not inhale or swallow. Avoid excessive contact with skin, eyes or mucous membranes. Keep out of reach of children.
6. Technical specifications of Akrapovič exhaust systems and related products subject to change without notice.

Trademarks

The Akrapovic Exhaust System Technology logo is a registered trademark of Akrapovič d.d.

Akrapovic website

Information about Akrapovič exhaust systems and related products is available on the Akrapovič website at:

<http://www.akrapovic.com/>

Copyright

No part of the Akrapovič exhaust system or its documentation may be reproduced or distributed in any form or by any means without the prior written authorization of the Akrapovič company.

© Akrapovič, d.d. All rights reserved.

Symbols

The following symbols are used throughout these installation instructions:



USE BOLT SEALANT; Apply 1 to 2 small drops of bolt sealant onto the cleaned and degreased threads before tightening bolts. **WARNING! Avoid contact with skin, eyes and mucous membranes. Do not inhale fumes. Keep out of the reach of children.**



USE ANTI-SEIZING GREASE (white tube); Prevents seizing, corrosion and excessive wear between the titanium components of your exhaust system. **WARNING! Avoid eye contact. Avoid excessive skin contact. Keep out of the reach of children.**



USE ANTI-SEIZE LEAD-FREE COPPER PASTE (black tube); Provides trouble-free and long-lasting protection against seizing, corrosion and rusting of bolts, threaded ends, nuts, joints, etc. Also protects against vibration, wear and impact. **WARNING! Avoid eye contact. Avoid excessive skin contact. Keep out of the reach of children.**

INSTALLATION INSTRUCTIONS

 **BEFORE INSTALLING CHECK SCHEMATIC OF THE EXHAUST SYSTEM!**

! IF ANY ITEMS IN THE AKRAPOVIC EXHAUST SYSTEM PACKAGE ARE MISSING PLEASE CONTACT YOUR AUTHORIZED DEALER. KEEP THE SCHEMATIC FOR FUTURE REFERENCE.

! THESE INSTALLATION INSTRUCTIONS MUST BE READ CAREFULLY IN ORDER TO ENSURE PROPER INSTALLATION AND OPERATION OF THE AKRAPOVIC EXHAUST SYSTEM.

! THE EXHAUST SYSTEM CAN BE EXTREMELY HOT. ALLOW THE MOTORCYCLE TO COOL DOWN BEFORE BEGINNING INSTALLATION.

 **WE ADVISE YOU TO LEAVE INSTALLATION TO A QUALIFIED SERVICEMAN. IMPROPER INSTALLATION MAY RESULT IN A SHORTER LIFETIME OF THE EXHAUST SYSTEM AND/OR DAMAGE TO THE MOTORCYCLE.**



T-handle 10 mm wrench
T-handle 12 mm wrench
T-handle 13 mm wrench
Combination 12 mm wrench
Combination 13 mm wrench
Combination 17 mm wrench
Combination 22 mm wrench
T-handle 4 mm three hexagon key wrench
T-handle 6 mm three hexagon key wrench
T-handle 6 mm swiveling three hexagon key wrench
Screwdriver for slotted head screw – small
Spring puller

REMOVAL OF STOCK EXHAUST SYSTEM:

1. Put the motorcycle on a side stand, we recommend a racing stand. Make sure, that surface is solid and flat.
2. Untighten the bolt from the metal clamp at the stock muffler/collector joint, unscrew the bolt from the muffler bracket and remove the muffler (**Figure 1, 2, 3**).



Figure 1



Figure 2



Figure 3

3. Remove the left and right cowling (Figure 4, 5, 6, 7, 8, 9).

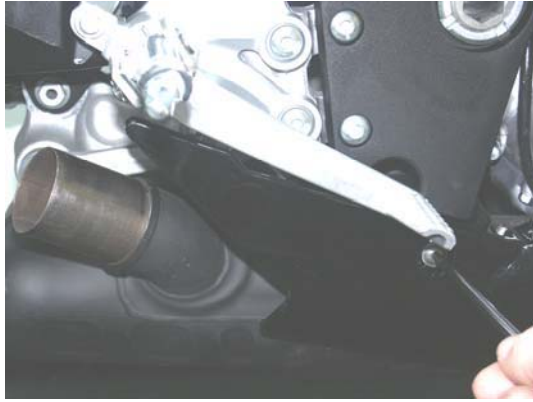

Figure 4



Figure 5



Figure 6



Figure 7



Figure 8



Figure 9

4. Unscrew the exhaust valve cables bracket and remove the cables from the valve wheel (Figure 10, 11).

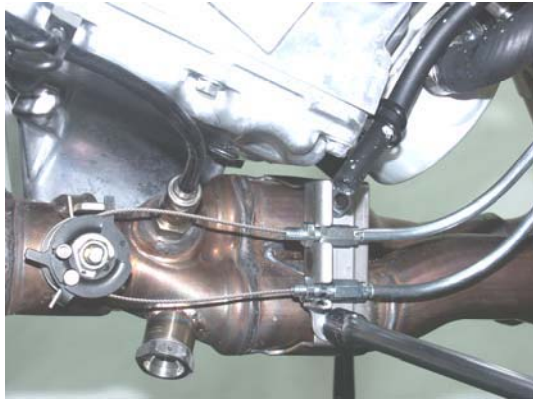

Figure 10

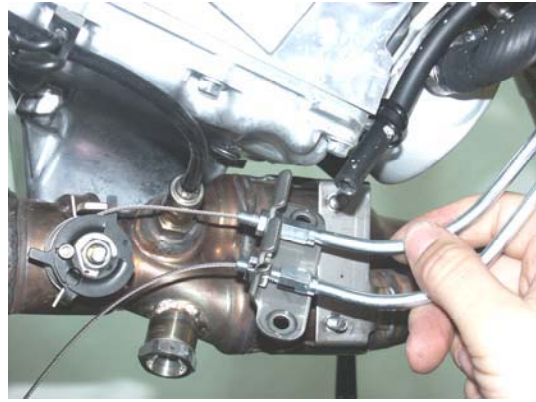

Figure 11

5. Unscrew the lambda sensor (Figure 12).



Figure 12

6. Unscrew and partially remove the water cooler (Figure 13, 14). **WARNING: do not disconnect the cooling system tubes!**



Figure 13



Figure 14

7. Unscrew the bolts from the header tube flanges; make sure not to damage the cooling fins (**Figure 15**). Unscrew three bolts from stock collector brackets and remove the collector/header tubes from the motorcycle; **WARNING: support the collector with your hand during this procedure or it may fall of and damage you or the motorcycle!** (**Figure 16, 17, 18, 19**). Leave the stock gaskets in the exhaust ports! Remove the metal inner sleeves from the rubber dampers of the collector hanging brackets (**Figure 20**).



Figure 15



Figure 16



Figure 17



Figure 18



Figure 19



Figure 20

8. Remove the rider's seat (Figure 21, 22). Unscrew and lift/secure the fuel tank (Figure 23, 24, 25).



Figure 21



Figure 22



Figure 23



Figure 24



Figure 25

9. Disconnect both connectors of the servo motor (**Figure 26, 27**). Unscrew and remove the servo's bracket as shown in figures (**Figure 28, 29, 30, 31**).



Figure 26



Figure 27



Figure 28



Figure 29



Figure 30



Figure 31

- Remove the cables from the control wheel and servo from the motorcycle (Figure 32, 33). Completely remove the cables with cable bracket from the motorcycle (Figure 34). Unscrew and remove the control wheel for cable position; **WARNING: do not turn the servo's wheel with force or the servo motor could be damaged. Retain the servo wheel in place with pliers when untightening!** (Figure 35).



Figure 32



Figure 33



Figure 34



Figure 35

INSTALLATION OF THE AKRAPOVIČ RACING, RACING1, RACING2 OR EVOLUTION, EVOLUTION1, EVOLUTION2 EXHAUST SYSTEM:

- Correctly position and install the Akrapovič servo motor rotation limiter (Figure 36, 37); **WARNING: do not over tighten the bolt – you can damage the axle and rotation ability of the servo motor – use pliers to retain the axle while tightening the limiter!**



Figure 36

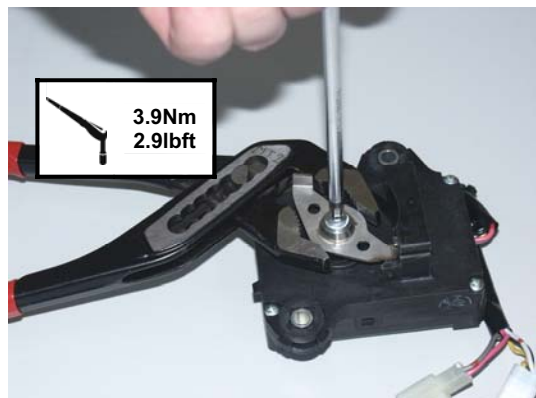

Figure 37

2. Screw the Akrapovič bracket onto the servo motor using stock bolt and Akrapovič M6 nut (Figure 38, 39). Put the servo motor on its place and reconnect both connectors (Figure 40, 41). Screw the servo motor onto the frame using stock bolts and tighten them to a specified torque (Figure 42). Reinstall the fuel tank and seat (Figure 43, 44).

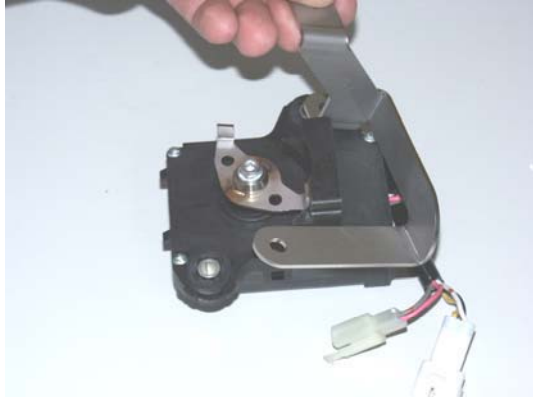

Figure 38

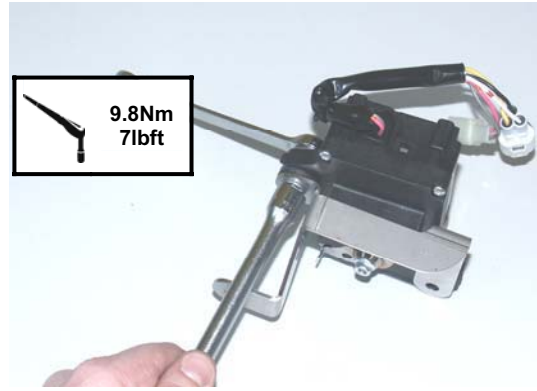

Figure 39



Figure 40



Figure 41

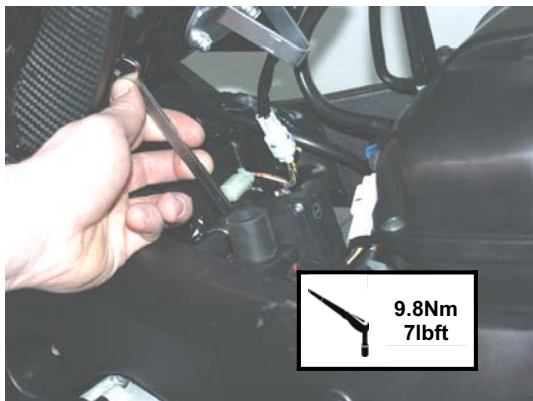

Figure 42



Figure 43



Figure 44

3. Set up the sleeves together with the flanges and springs and hand tighten the flanges using stock bolts; make sure that flanges are correctly oriented (**Figure 45, 46**).



Figure 45



Figure 46

4. Insert the header tubes properly and attach the springs; make sure not to damage the cooling fins (**Figure 47**). Tighten the flanges to specified torque; make sure not to damage the cooling fins. Make sure the header tubes are not touching the engine, other tubes, electrical installations etc.

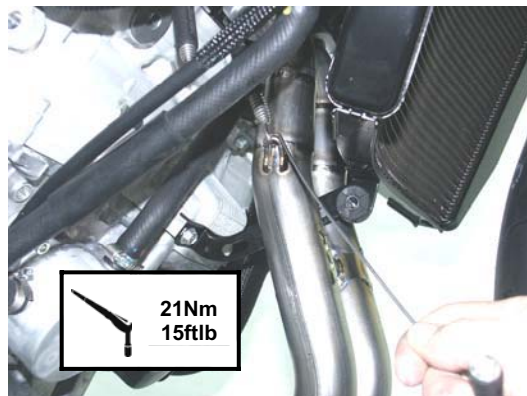

Figure 47

- Make sure the collectors are correctly oriented. Slide the collectors onto the header tubes and attach the springs; **For Evolution exhaust only:** coat the interior side of the input bushes of the titanium collector with Akrapovič ceramic anti-seizing grease - white tube (Figure 48, 49). Reattach the bolt from the water cooler hanging bracket (Tightening torque: 9.8Nm / 7ftlb).

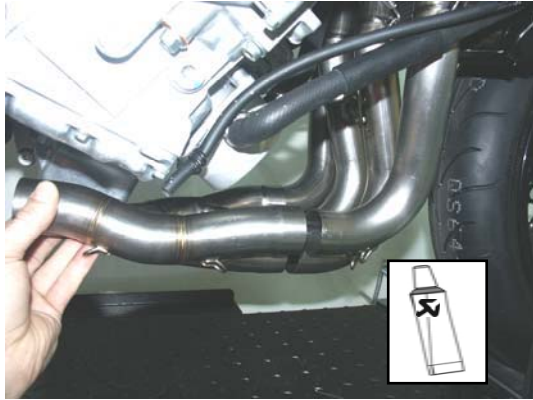

Figure 48



Figure 49

- FOR RACING/RACING1 & EVOLUTION/EVOLUTION1 EXHAUSTS ONLY:** Slide the link pipe onto the collectors and attach the springs; **For Evolution exhaust only:** coat the interior side of the input bushes of the titanium collector with Akrapovic ceramic anti-seizing grease - white tube (Figure 50, 51). Tighten the lambda sensor; make sure the electrical lead is correctly positioned (Figure 52, 53). **WARNING: grease only the threads of the lambda sensor!**

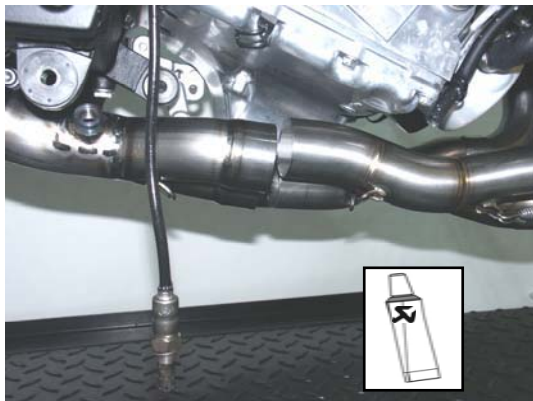

Figure 50



Figure 51

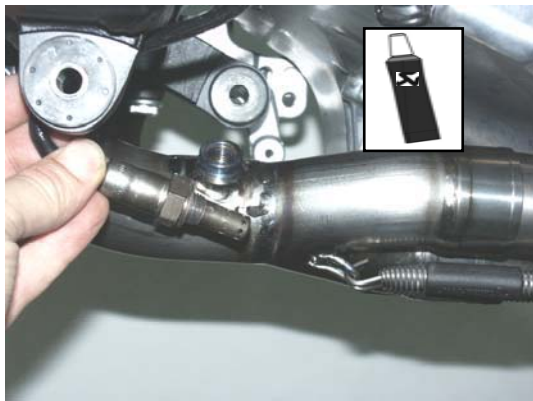

Figure 52

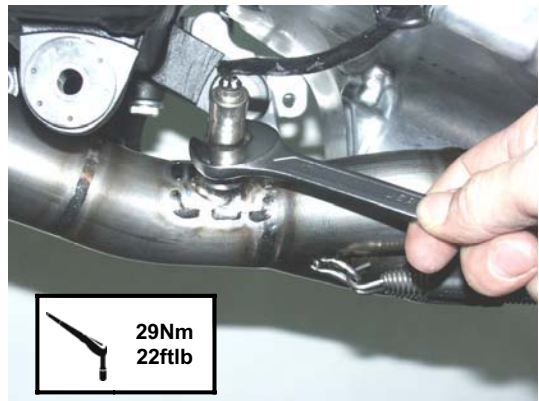

Figure 53

7. Correctly position the carbon-fiber clamp and slide it onto the muffler - bear in mind **the left offset** of the carbon-fiber clamp viewed from the rear. **WARNING: open the clamp to slightly wider than the diameter of the outer sleeve of the muffler – do not scrape it along the muffler outer sleeve! (Figure 54).** For Evolution exhaust only: coat the interior side of the input bush of the muffler with Akrapovič ceramic anti-seizing grease (white tube). Position the muffler correctly and slide it onto the outlet side of the link pipe (Figure 55). Position and attach the springs (Figure 56). **FOR RACING1 & EVOLUTION1 EXHAUSTS ONLY:** Unscrew both passengers foot pegs (Figure 57). Correctly position and tighten additional carbon-fiber bracket. Use stock bolts (Figure 58).



Figure 54



Figure 55



Figure 56



Figure 57



Figure 58

8. Tighten the bolt of the carbon-fiber clamp/stock muffler bracket joint, using stock bolt, nut and washer (**Figure 59, 60**). For **Racing1 & Evolution1 exhaust only**: Tighten the bolt of the carbon-fiber clamp/muffler bracket joint, using Akrapovič bolt, nut and washer (**Figure 61**). Make sure the muffler is not touching the swing arm or any other parts of the motorcycle.



Figure 59



Figure 60



Figure 61

9. **FOR RACING2 & EVOLUTION2 EXHAUSTS ONLY**: Unscrew the bolts from the driver's right foot peg bracket (slightly remove the bracket) (**Figure 62**). Install the Akrapovič muffler bracket (**Figure 63**). Tighten the foot peg bracket on its position (**Figure 64**).



Figure 62



Figure 63

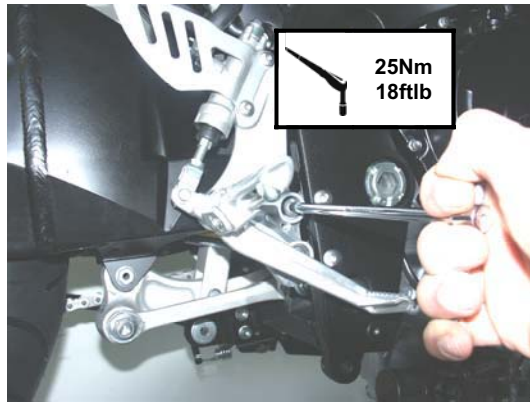

Figure 64

10. Attach the press-on nut onto the link pipe bracket (Figure 65, 66).



Figure 65



Figure 66

11. Slide the muffler with link pipe onto the collectors and attach the springs (Figure 67, 68). For Evolution exhaust only: coat the interior side of the input bushes of the titanium link-pipe with Akrapovič ceramic anti-seizing grease (white tube). Hand tighten the bolt of the link-pipe bracket (Figure 69). Attach and tighten the lambda sensor; **WARNING: grease only the threads of the lambda sensors!** (Figure 70). Correctly position the carbon-fiber clamp and slide it onto the muffler - bear in mind the left offset of the carbon-fiber clamp viewed from the rear. **WARNING: open the clamp slightly wider than the diameter of the outer sleeve of the muffler – do not scrape it along the muffler outer sleeve!** (Figure 71). Tighten the carbon-fiber clamp onto the Akrapovič clamp bracket (Figure 72). Tighten the link-pipe bracket (Figure 73).

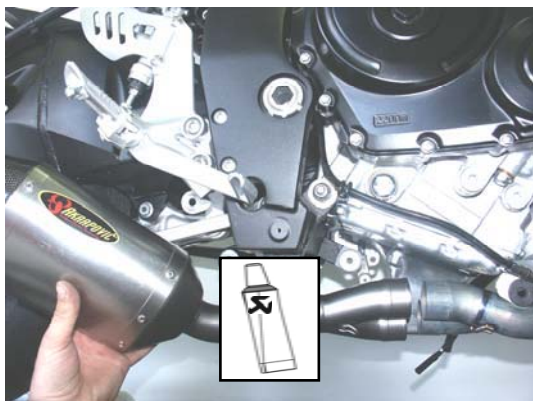

Figure 67



Figure 68

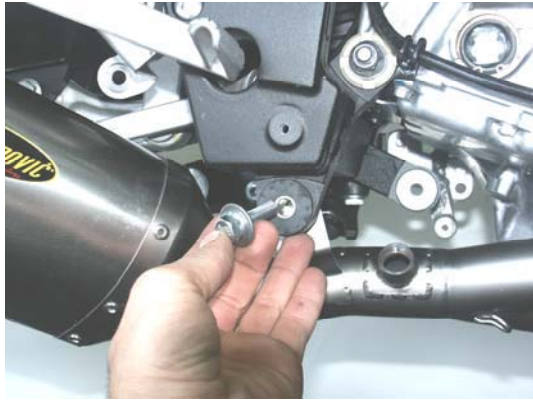

Figure 69

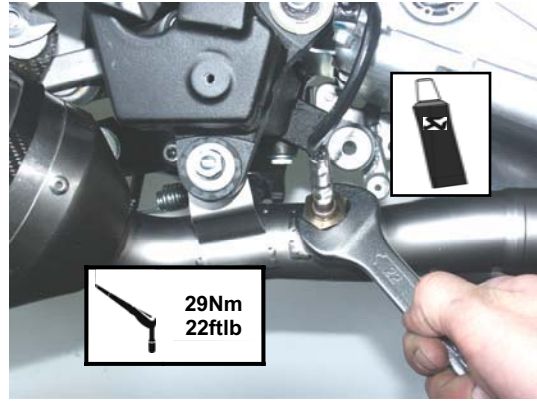

Figure 70



Figure 71

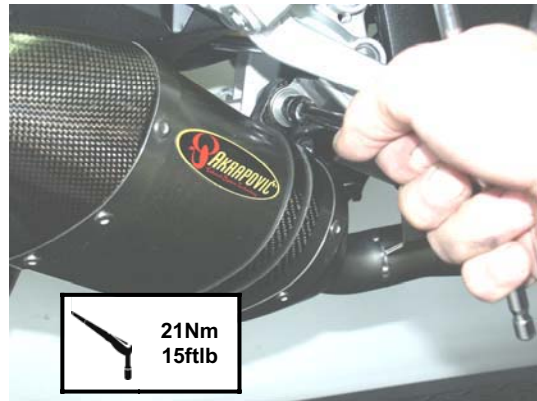

Figure 72

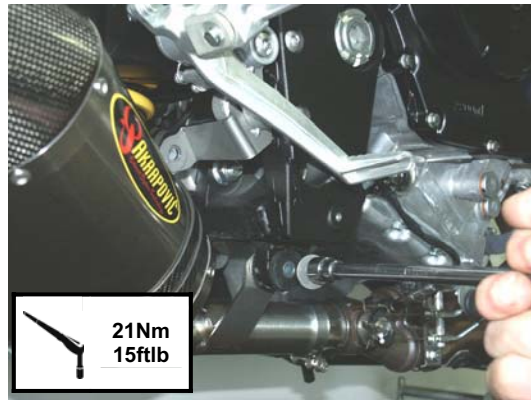

Figure 73

12. Replace all cowlings in the reverse order from the order in which they were removed (Figure 74, 75).



Figure 74

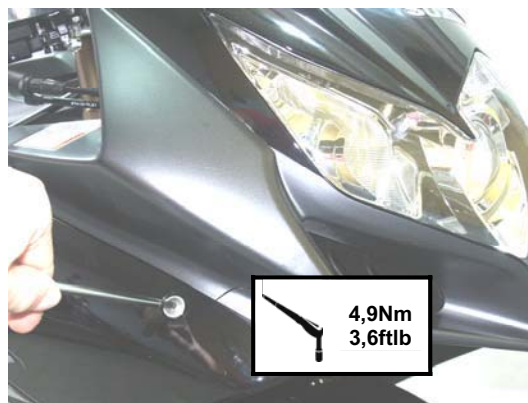

Figure 75

Final installation:

1. Clean grease spots:
 - a. Muffler – carbon-fiber outer sleeve: use a soft dry cloth.
 - b. Muffler – titanium outer sleeve: use a soft cloth sprayed with a multi-purpose spray lubricant (WD-40 or equivalent).
 - c. Muffler – carbon-fiber outlet cap: use a soft dry cloth.
 - d. RACING - stainless steel link pipe, collectors and header tubes: use a soft cloth sprayed with a contact cleaner, then wipe with a soft dry cloth
 - e. EVOLUTION - titanium link pipe, collectors and header tubes: use a soft cloth sprayed with a multi-purpose spray lubricant (WD-40 or equivalent).

Cleaning will prevent spots from burning onto the surface. Do not use aggressive chemical cleaners, because they can damage the sticker.

WARNING! ; AFTER EXHAUST SYSTEM CHANGE, YOU SHOULD CHECK THE LAMBDA SENSOR VALUE. IF YOUR AIR TO FUEL RATIO IS TOO HIGH THE ENGINE COULD BE DAMAGED. WE RECOMMEND A FUEL INCREASE BY 10% (THIS SHOULD BE DONE BY SUZUKI SERVICE!).

Position of the correctly installed Akrapovič RACING or EVOLUTION system (Figure 76).



Figure 76

Position of the correctly installed Akrapovič **RACING1** or **EVOLUTION1** system (Figure 77).



Figure 77

Position of the correctly installed Akrapovič **RACING2** or **EVOLUTION2** system (Figure 78).



Figure 78

Position of the correctly installed Akrapovič **EVOLUTION** system with conical muffler (**Figure 79**).



Figure 79

2. Check the operation of the brakes and suspension. Make sure all the bolts are sufficiently tightened. In case the exhaust system touches the cowling or other parts repeat the adjustment of the exhaust system or contact your authorized dealer.

! IT IS NORMAL IF WHITE SMOKE COMES OUT OF THE MUFFLER ON FIRST OPERATION.

! DO NOT STAND BEHIND THE MUFFLER ON FIRST OPERATION.

! DO NOT USE AUTOMOTIVE WHEEL CLEANERS OR ANY CLEANING PRODUCTS WHICH CONTAIN ACIDIC ADDITIVES TO CLEAN AKRAPOVIČ EXHAUST SYSTEMS.

MAINTENANCE OF THE AKRAPOVIČ EXHAUST SYSTEM

1. Clean the titanium exhaust components with a multi-purpose spray lubricant (WD-40 or equivalent), carbon fiber exhaust components with soft and dry cloth and stainless steel components with soft cloth sprayed with contact cleaner, then wipe with soft and dry cloth. Do not use aggressive chemical cleaners, because they can damage the sticker. A change in the color of the exhaust system is normal due to the high temperatures.
2. The wearing out of the muffler silencing material depends on the type of the engine and riding style. Contact your dealer/serviceman if visible changes appear on muffler's outer sleeve or the noise level is increased.
3. Periodically make sure all the bolts and springs are sufficiently tight.

SUZUKI GSX-R 600/750 Complete exhaust system/Racing line/Open, model year: 2008 - 2009

Product code: S-S6R7L-ZC
S-S6R7L-ZT

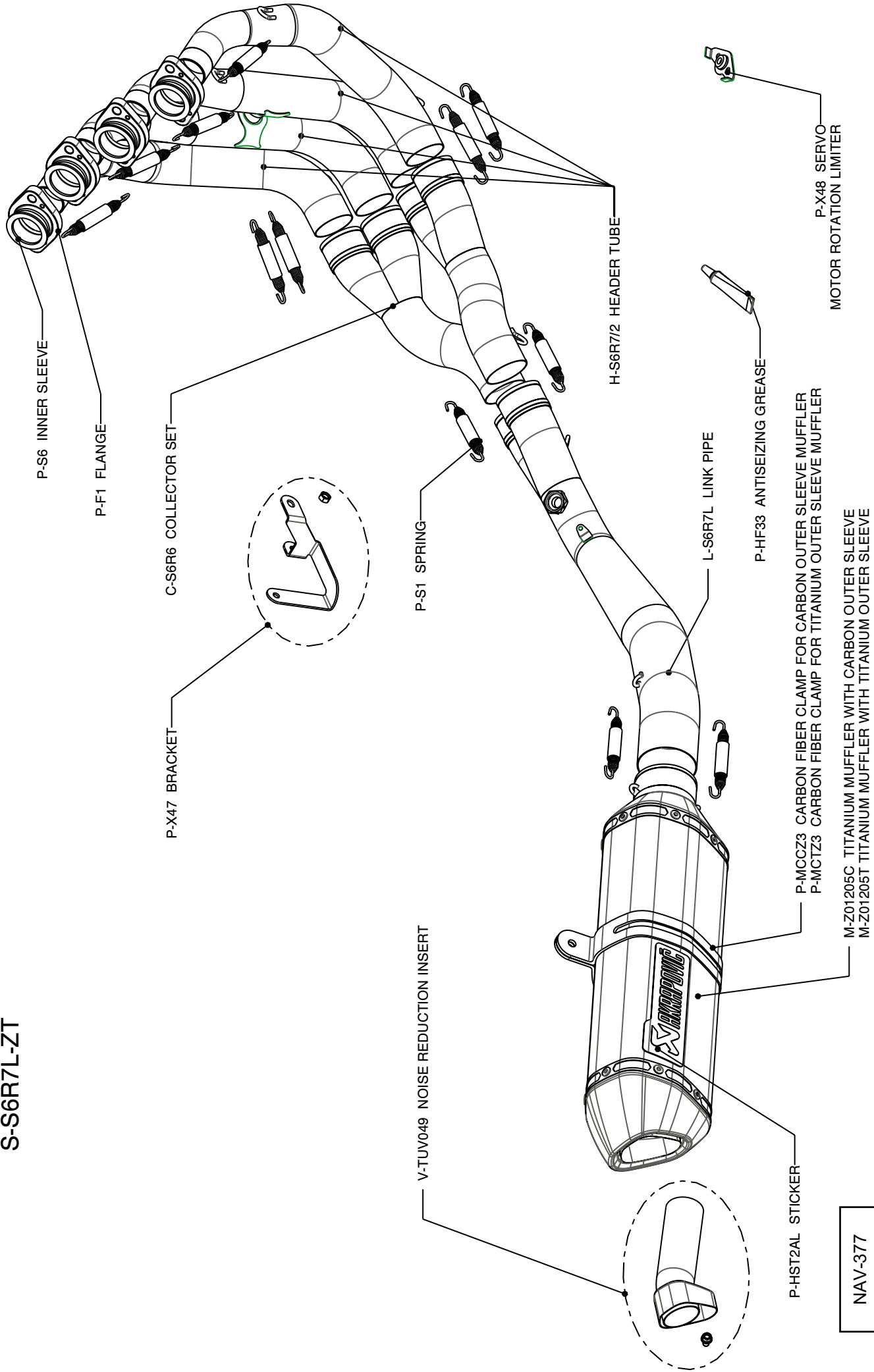

SUZUKI GSX-R 600/750 Complete exhaust system/Evolution line/Open, model year: 2008 - 2009

Product code: S-S6RFT7TL-ZC
S-S6RFT7TL-ZT

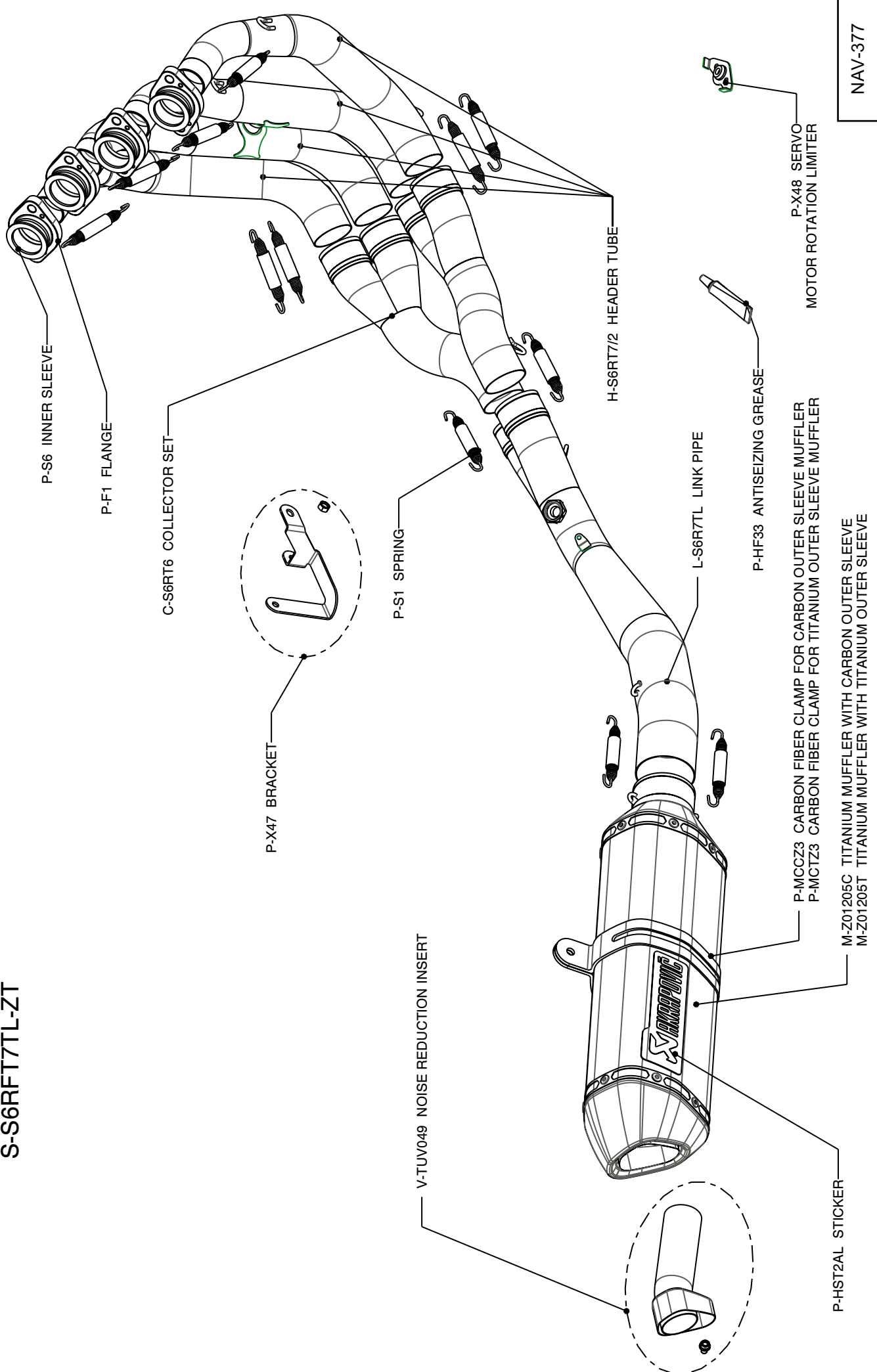

SUZUKI GSX-R 600/750 Complete exhaust system/Racing1 system, model year: 2008 - 2009

Product code: S-S6R7L-ZC/2
S-S6R7L-ZT/2

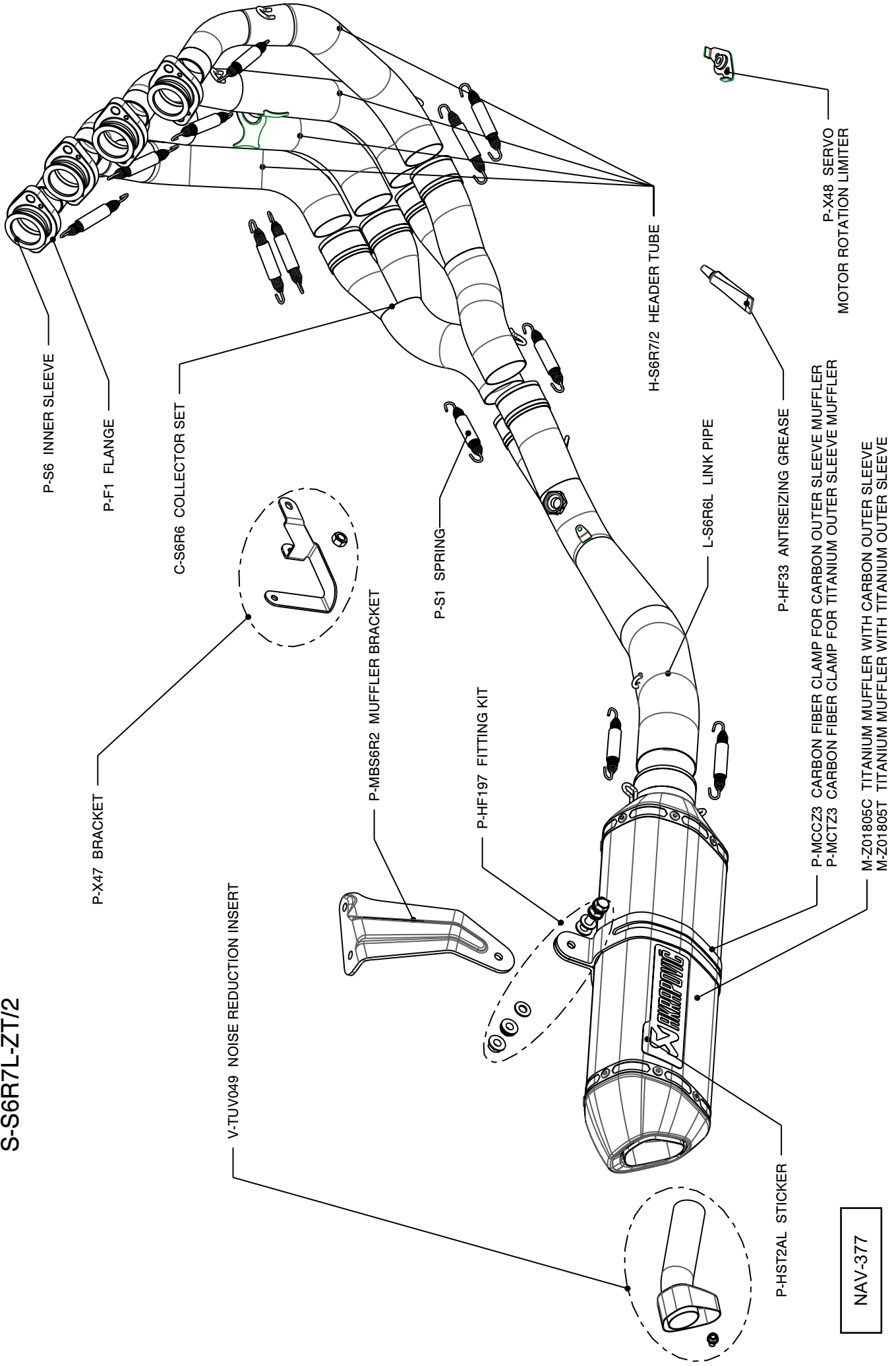

SUZUKI GSX-R 600/ 750 Complete exhaust system/ Evolution1 system, model year: 2008 - 2009

Product code: S-S6RFT7TL-ZC/2
S-S6RFT7TL-ZT/2

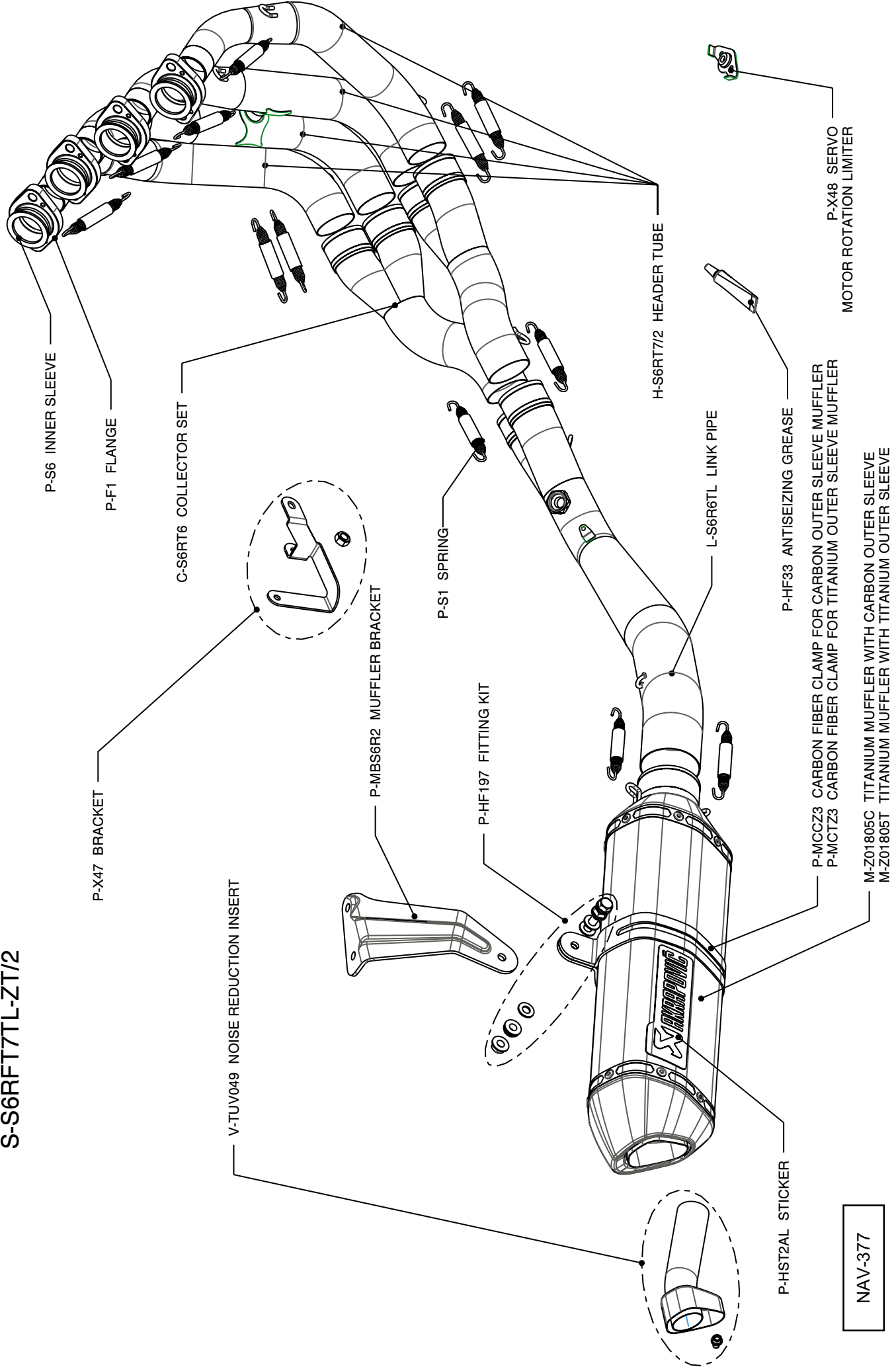

SUZUKI GSX-R 600/750 Complete exhaust system/ Racing line tube set with street legal Slip-on muffler,

WARNING! IN CASE OF COMBINATION WITH RACING TUBE SET, THE SLIP-ON HOMOLOGATION IS NOT VALID!

model year: 2008 - 2009

Product code: S-S6R7L-ZC/1
S-S6R7L-ZT/1

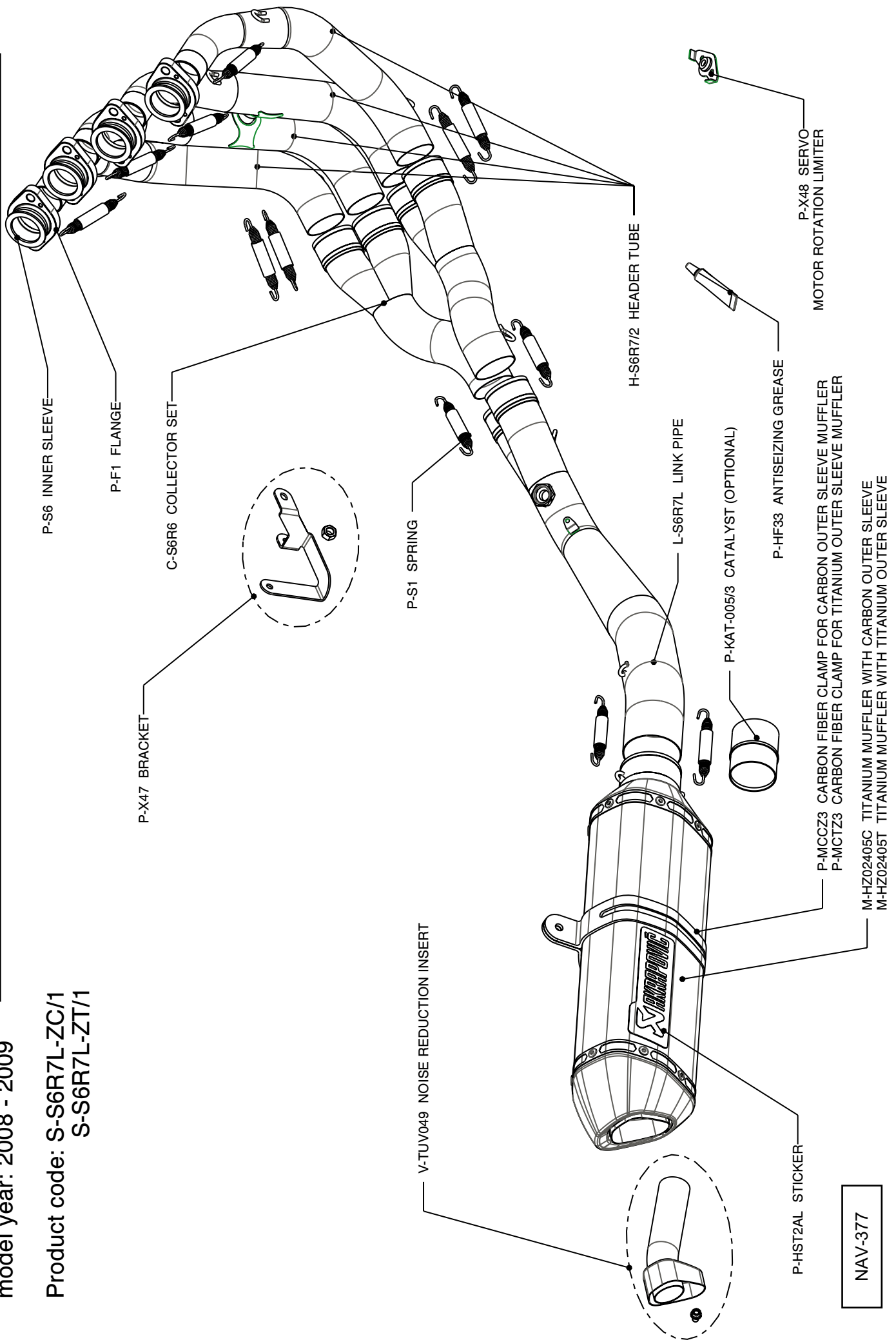

SUZUKI GSX-R 600/ 750 Complete exhaust system/ Evolution line tube set with street legal Slip-on muffler,

model year: 2008 -2009

WARNING! IN CASE OF COMBINATION WITH EVOLUTION TUBE SET, THE SLIP-ON HOMOLOGATION IS NOT VALID!

Product code: S-S6RFT7TL-ZC/1
S-S6RFT7TL-ZT/1

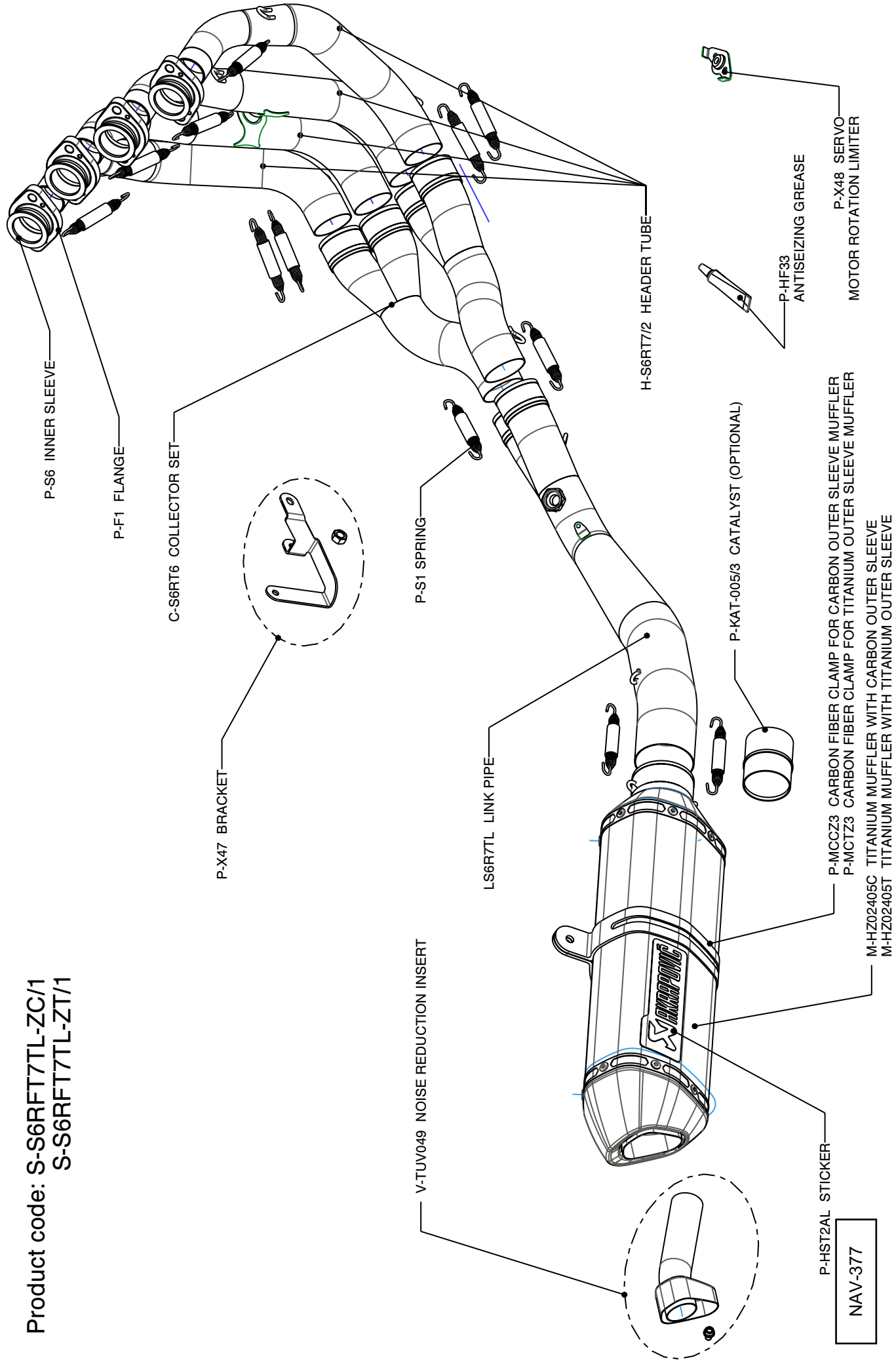

SUZUKI GSX-R 600/ 750 Complete exhaust system/ Evolution line/ OPEN, model year: 2008 - 2009

Product code: S-S6RFT7TL-XT

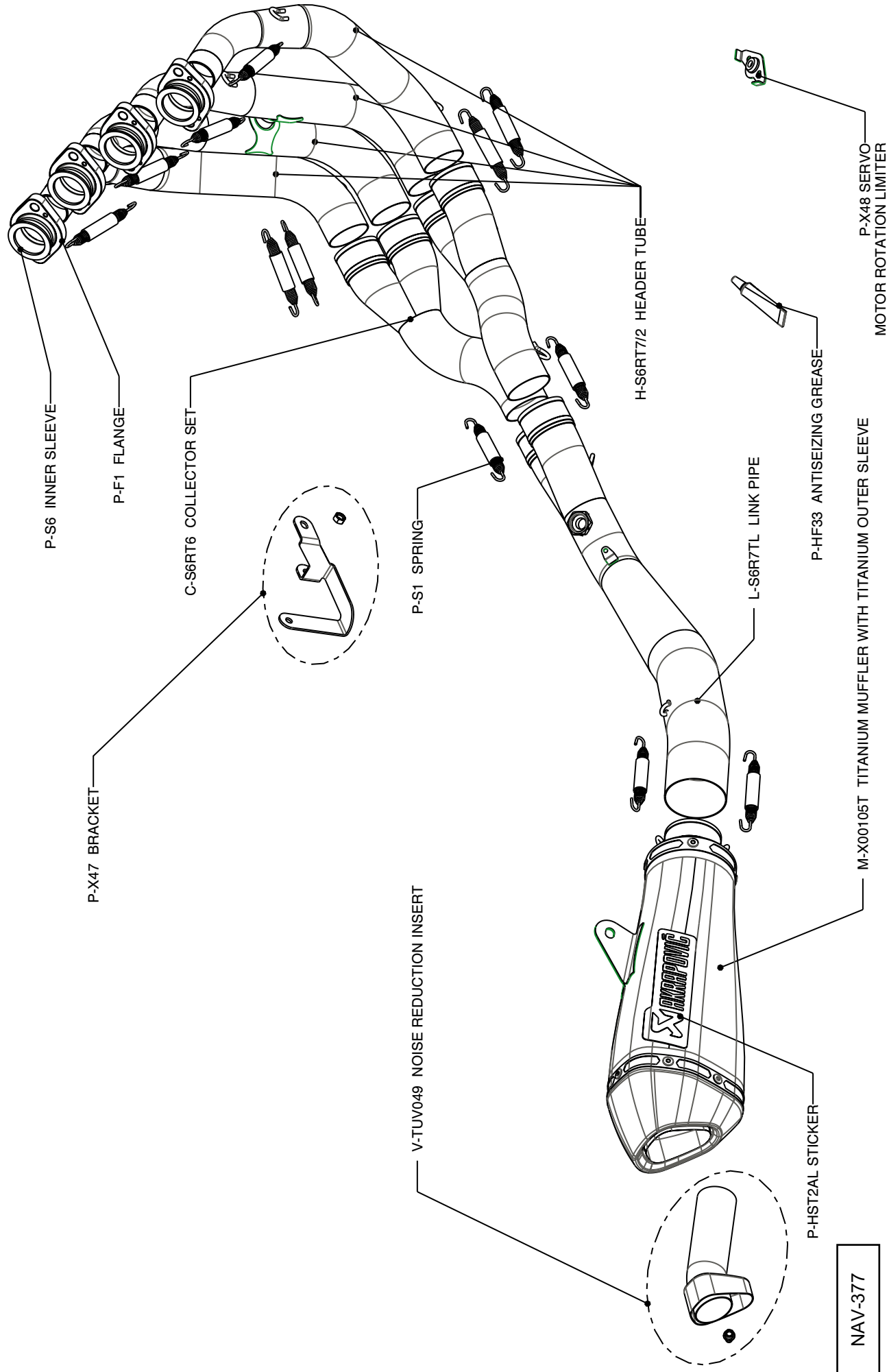

SUZUKI GSX-R 600 Complete exhaust system/Racing2 line, model year: 2008

Product code: S-S6R8-TC
S-S6R8-TT

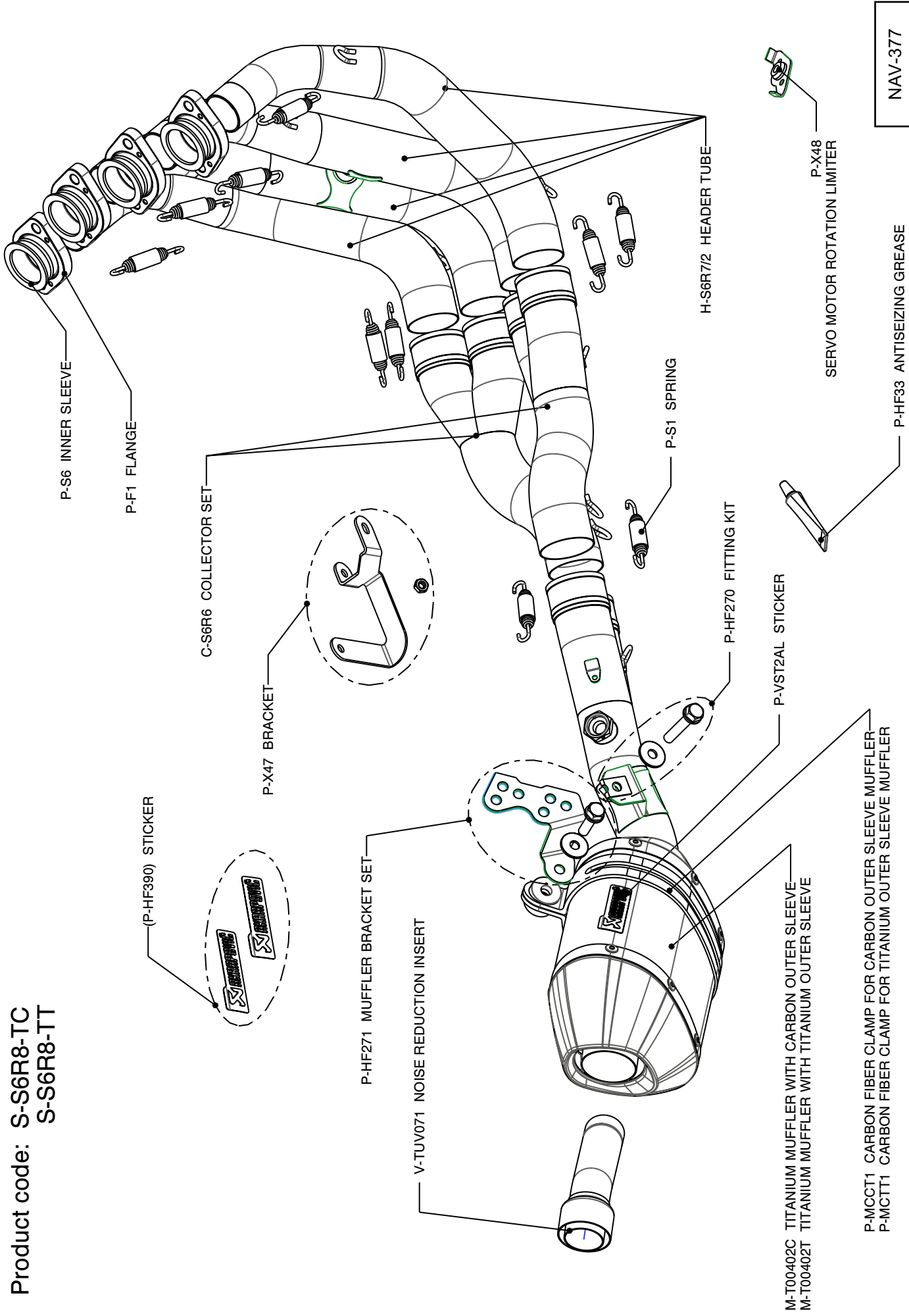

SUZUKI GSX-R 600 Complete exhaust system/ Evolution2 line, model year: 2008 - 2009

Product code: S-S6RFT8-TC
S-S6RFT8-TT

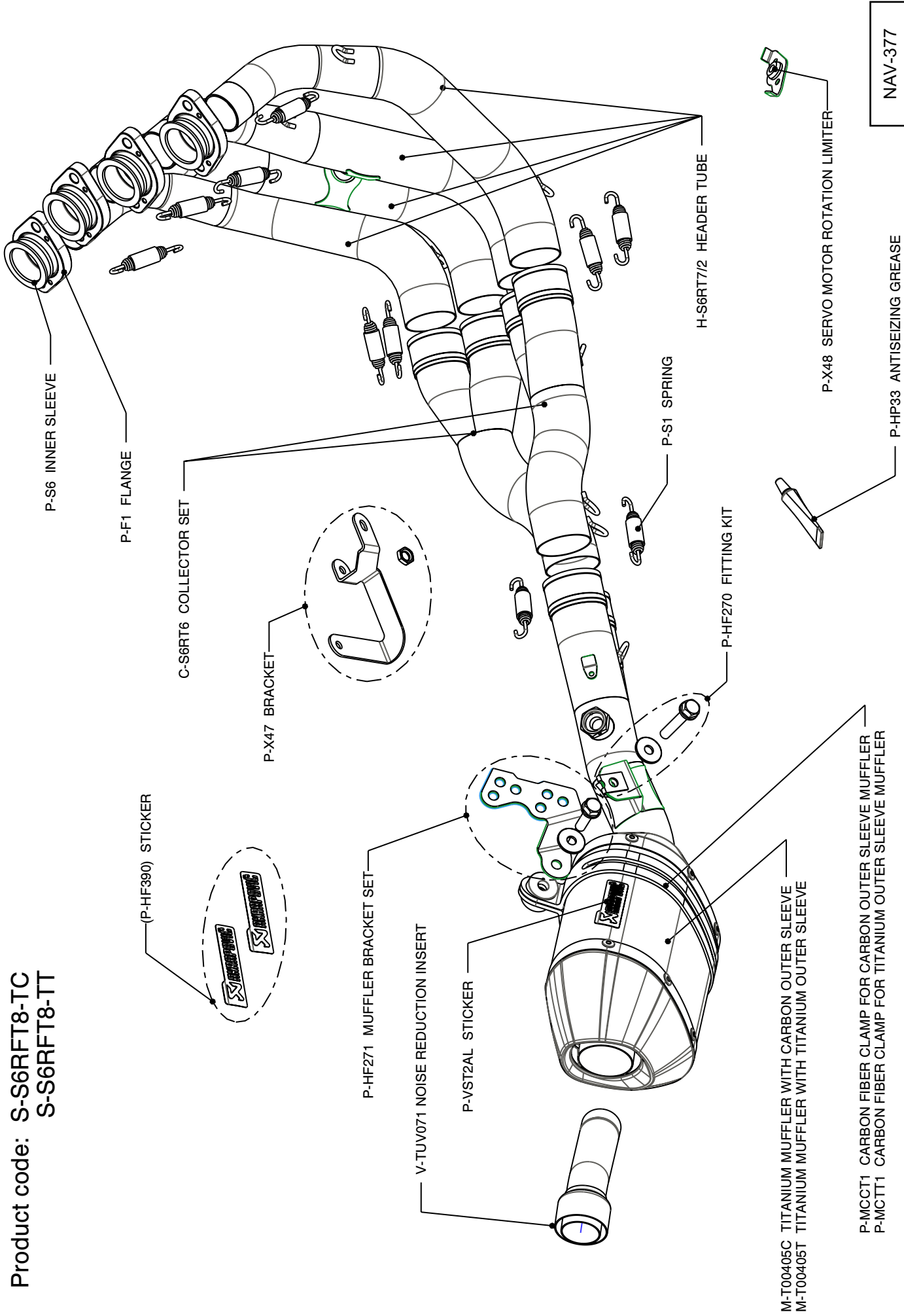

SUZUKI GSX-R 750 Complete exhaust system/Racing2 line, model year: 2008 - 2009

Product code: S-S7R8-TC
S-S7R8-TT

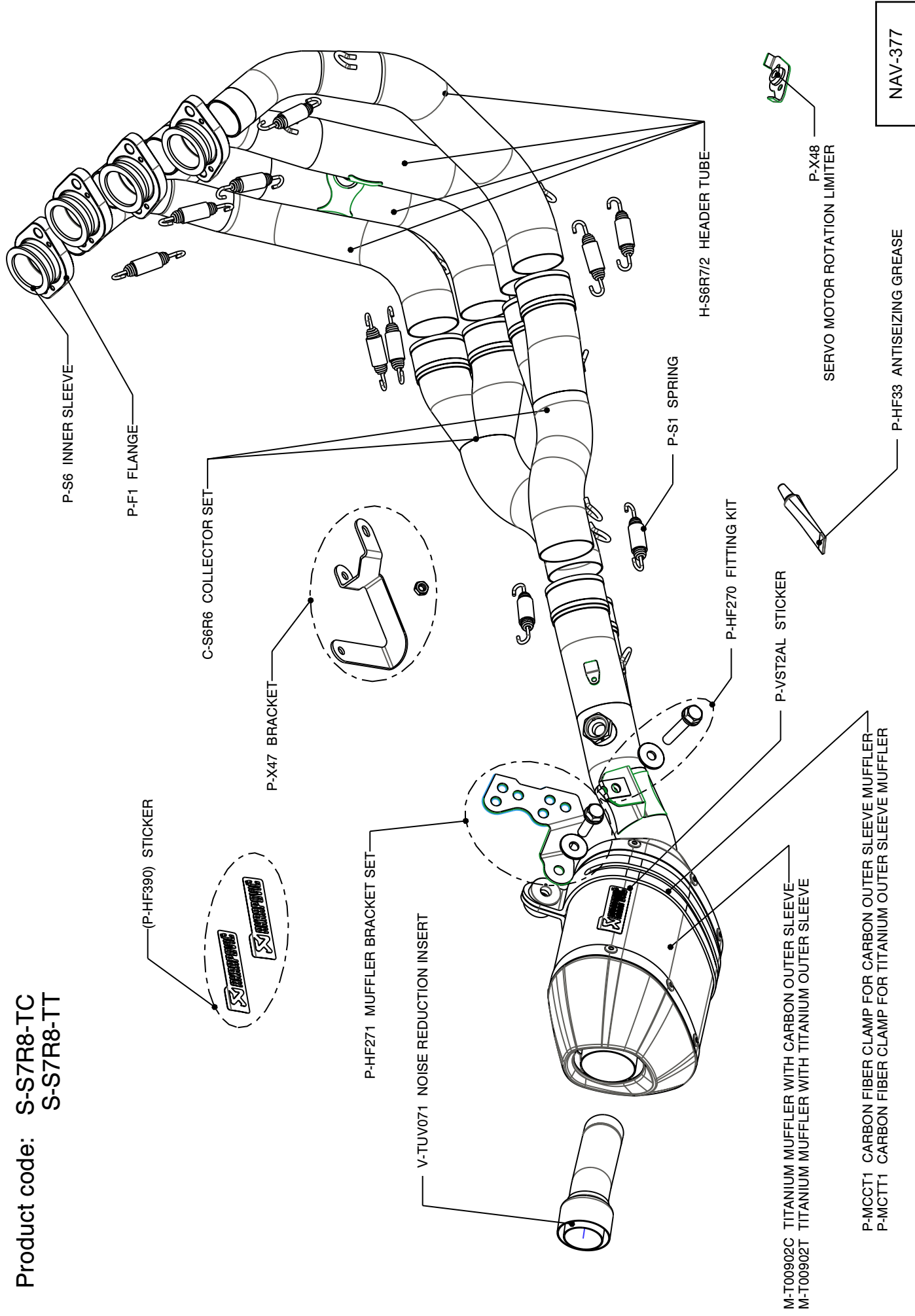

SUZUKI GSX-R 750 Complete exhaust system/ Evolution2 line, model year: 2008 - 2009

Product code: S-S7RFT8-TC
S-S7RFT8-TT

