



## Installation instructions

Akrapovič Exhaust System:

**Slip-On**

for the

**SUZUKI GSX 1250 F/FA 2010,**

**SUZUKI GSF 650 BANDIT 2007-2010,**

**SUZUKI GSF 1250 BANDIT 2007-2010,**

**SUZUKI GSX 650 F 2008-2010**

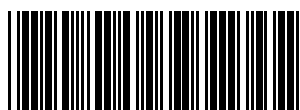

\*502771\*

**Congratulations on purchasing an Akrapovič exhaust system. Please read the entire installation manual prior to undertaking any activities related to installation of your new Akrapovič exhaust system. In case you do not fully understand the manual or any of its parts, please contact your authorized dealer!**

**This product should be installed by someone with sufficient knowledge of exhaust systems and their installation, and appropriate hand or power tools. If you are not qualified for this work, please utilize a certified mechanic for installation. By installing Your Akrapovič exhaust system, you indicate that you have read the installation manual in its entirety and you agree with the terms stated herein.**

**It is your responsibility to follow all installation instruction guidelines supplied with the Akrapovič exhaust system and undertake all necessary safety precautions. Akrapovič d.d. assumes no responsibility for damages occurring from misuse, abuse, improper installation, improper operation, lack of responsible care, or all previously stated reasons resulting from incompatibility with other manufacturer's products and/or systems.**

## **IMPORTANT INFORMATION**

### **Exclusion of Certain Liability**

1. The manufacturer, importer or dealer shall not be liable for any incidental damage including personal injury or any other damages caused by improper installation or operation of the Akrapovič exhaust system. When installing the Akrapovič exhaust system be careful that the exhaust system does not touch other parts sensitive to high temperature.
2. Akrapovič makes no representation or warranties with regard to damage caused by the improper installation, use and maintenance of the Akrapovič exhaust system. The warranty is limited to defects recognized by our technical department and due to normal use, and excludes items subject to normal wear (gaskets and damping wool). The guarantee is void in case of accident, modification, improper or competition use.
3. Do not attempt to install the Akrapovič exhaust system on a vehicle model for which it was not made or tested by Akrapovič.
4. When the exhaust system gets very hot during operation, be careful not to burn yourself on the exhaust system or parts which are in direct contact with it, even when the engine is not running. Also protect other people, especially children, from the injuries mentioned above.
5. In some cases Akrapovič exhaust system kits contain chemical products (ceramic anti-seizing grease; bolt sealant). Handle with care, do not inhale or swallow. Avoid excessive contact with skin, eyes or mucous membranes. Keep out of reach of children.
6. Technical specifications of Akrapovič exhaust systems and related products are subject to change without notice.
7. Before removing the original exhaust system from your vehicle, please compare the parts you received with the list of materials provided in the installation manual in order to assure that you have all the parts necessary for the installation of your new Akrapovič exhaust system.
8. Although this manual consists of instructions for installation in written form, as well as photographs and pictures representing individual steps of the installation, please note that the photographs and pictures are symbolic and are intended for representation of general overview only. The photographs and pictures contained herein should serve as a guideline only and actual installation of the exhaust system may not correspond with the photographs and pictures entirely.
9. The process of uninstalling the original exhaust system may vary depending on the existing exhaust system. Please follow the original exhaust system manufacturer's instructions for uninstalling the original exhaust system.

### **Trademarks**

The Akrapovič Exhaust System Technology logo is a registered trademark of Akrapovič d.d.

### **Akrapovič website**

Information about Akrapovič exhaust systems and related products is available on the Akrapovič website at: <http://www.akrapovic.com/>

### **Copyright**

No part of the Akrapovič exhaust system or its documentation may be reproduced or distributed in any form or by any means without the prior written authorization of the Akrapovič company.

© Akrapovič, d.d. All rights reserved.

## Symbols

The following symbols are used throughout these installation instructions:



TOOLS REQUIRED



TIGHTENING TORQUE



INSTALLATION TIP



CAUTION OR WARNING



**USE BOLT SEALANT;** Apply 3 to 4 small drops of bolt sealant onto the cleaned and degreased threads before tightening the bolts. **WARNING! Avoid contact with skin, eyes and mucous membranes. Do not inhale fumes. Keep out of reach of children.**



**USE ANTI-SEIZE LEAD-FREE COPPER PASTE** (black tube); Provides trouble-free and long-lasting protection against seizing, corrosion and rusting of bolts, threaded ends, nuts, joints, etc. Also protects against vibration, wear and impact. **WARNING! Avoid eye contact. Avoid excessive skin contact. Keep out of reach of children.**



**USE ANTI-SEIZING GREASE** (white tube); Prevents seizing, corrosion and excessive wear between the titanium components of your exhaust system. **WARNING! Avoid eye contact. Avoid excessive skin contact. Keep out of reach of children.**

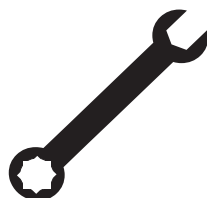

T-handle 12 mm wrench  
T-handle 6 mm three hexagon key wrench  
Combination 12 mm wrench  
Combination 13 mm wrench



**BEFORE INSTALLING, CHECK SCHEMATIC OF THE EXHAUST SYSTEM!**



**IF ANY ITEMS IN THE AKRAPOVIČ EXHAUST SYSTEM PACKAGE ARE MISSING, PLEASE CONTACT YOUR AUTHORIZED DEALER. KEEP THE SCHEMATIC FOR FUTURE REFERENCE.**



**THESE INSTALLATION INSTRUCTIONS MUST BE READ CAREFULLY IN ORDER TO ENSURE PROPER INSTALLATION AND OPERATION OF THE AKRAPOVIČ EXHAUST SYSTEM.**



**THE EXHAUST SYSTEM CAN BE EXTREMELY HOT. ALLOW THE EXHAUST AND ENGINE TO COOL DOWN BEFORE BEGINNING INSTALLATION.**



**WE ADVISE YOU TO LEAVE INSTALLATION TO A QUALIFIED SERVICEMAN. IMPROPER INSTALLATION MAY RESULT IN A SHORTER LIFETIME OF THE EXHAUST SYSTEM AND/OR DAMAGE TO THE VEHICLE.**

**REMOVAL OF STOCK EXHAUST SYSTEM:**

1. Put the motorcycle on a side stand, we recommend a racing stand.
2. Untighten the marked link pipe clamp, unscrew the marked muffler bracket bolt and remove the stock muffler off the motorcycle (Figure 1, 2).

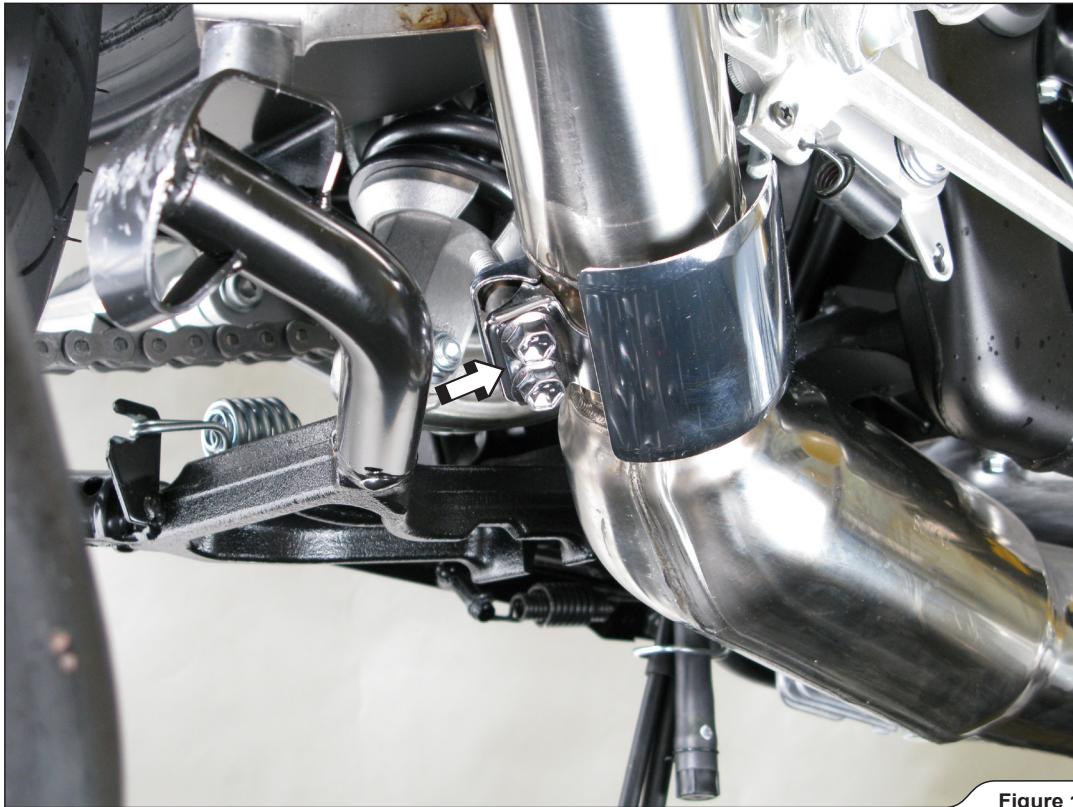

Figure 1



Figure 2

### **INSTALLATION OF THE AKRAPOVIČ EXHAUST SYSTEM:**

1. Instal Akrapovič metal clamp onto the muffler inlet as shown (Figure 3).  
**For S-S12SO3-HRC/HRT SO exhaust only:** displace the market stock central stand rubber stopper from stock to Akrapovič muffler.

**! WARNING:** use anti-seize copper paste on bolt threads of the metal clamp!



Figure 3

2. Correctly position the carbon-fiber clamp and slide it onto the muffler - bear in mind the **left offset** of the carbon-fiber clamp viewed from the rear; check the position of the yellow sticker on the clamp (Figure 4).

**! WARNING:** open the clamp slightly wider than the diameter of the outer sleeve of the muffler – do not scrape it along the muffler outer sleeve!



Figure 4

3. **For models with side cases:** correctly position the carbon-fiber clamp and slide it onto the muffler - bear in mind the **right offset** of the carbon-fiber clamp viewed from the rear; check the position of the yellow sticker on the clamp (Figure 5).  
**! WARNING:** open the clamp slightly wider than the diameter of the outer sleeve of the muffler – do not scrape it along the muffler outer sleeve!

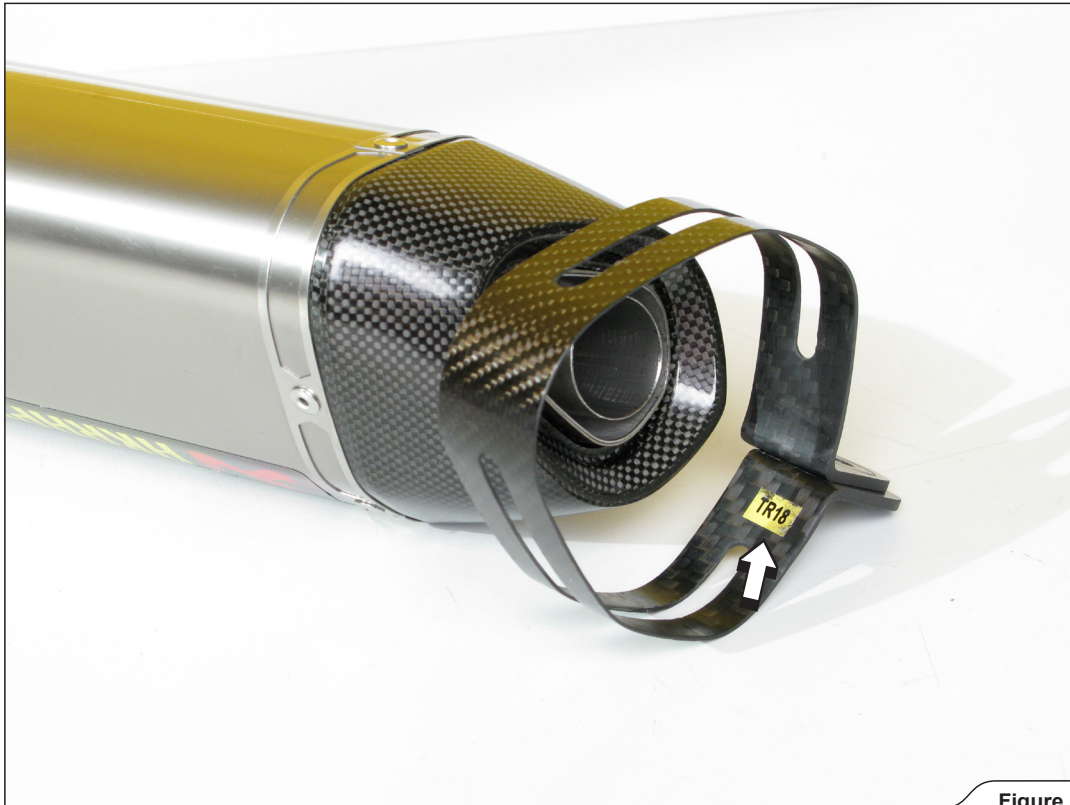

Figure 5

4. Position the muffler correctly and slide it onto the outlet side of stock link pipe. Align the muffler in respect to the motorcycle and tighten the muffler clamp (using Akrapovič bolt, washers and nut) and metal clamp to a specified torque (Figure 6, 7).

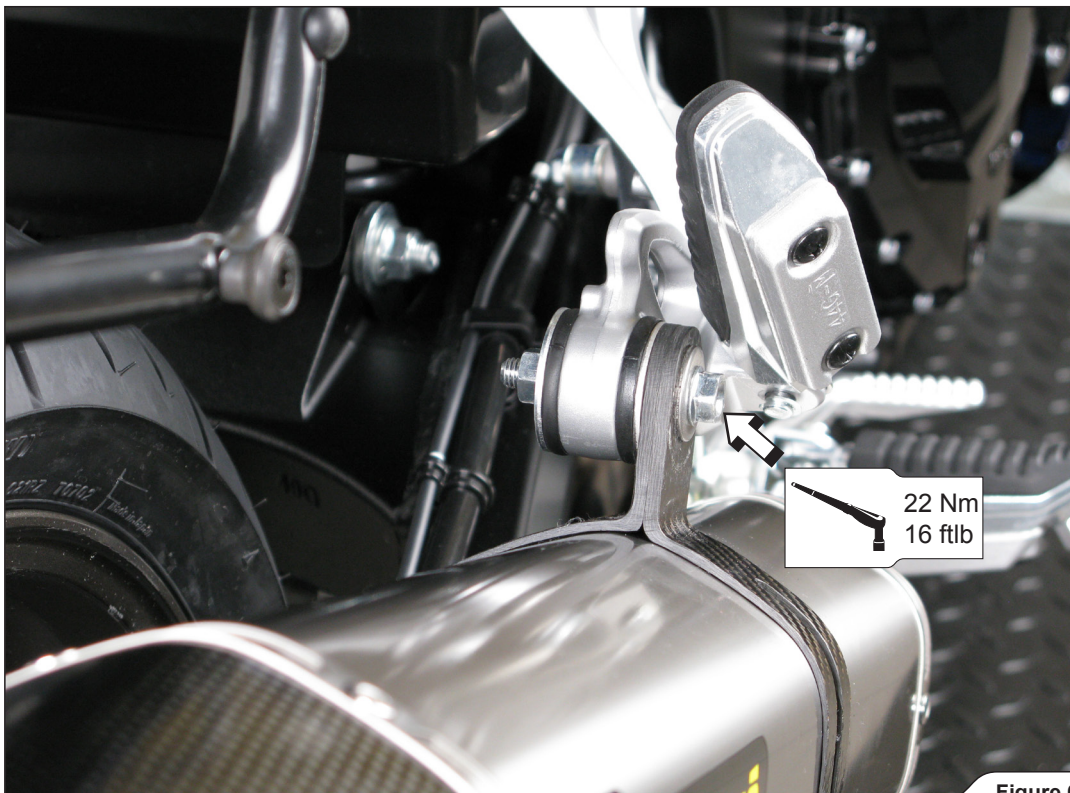

Figure 6

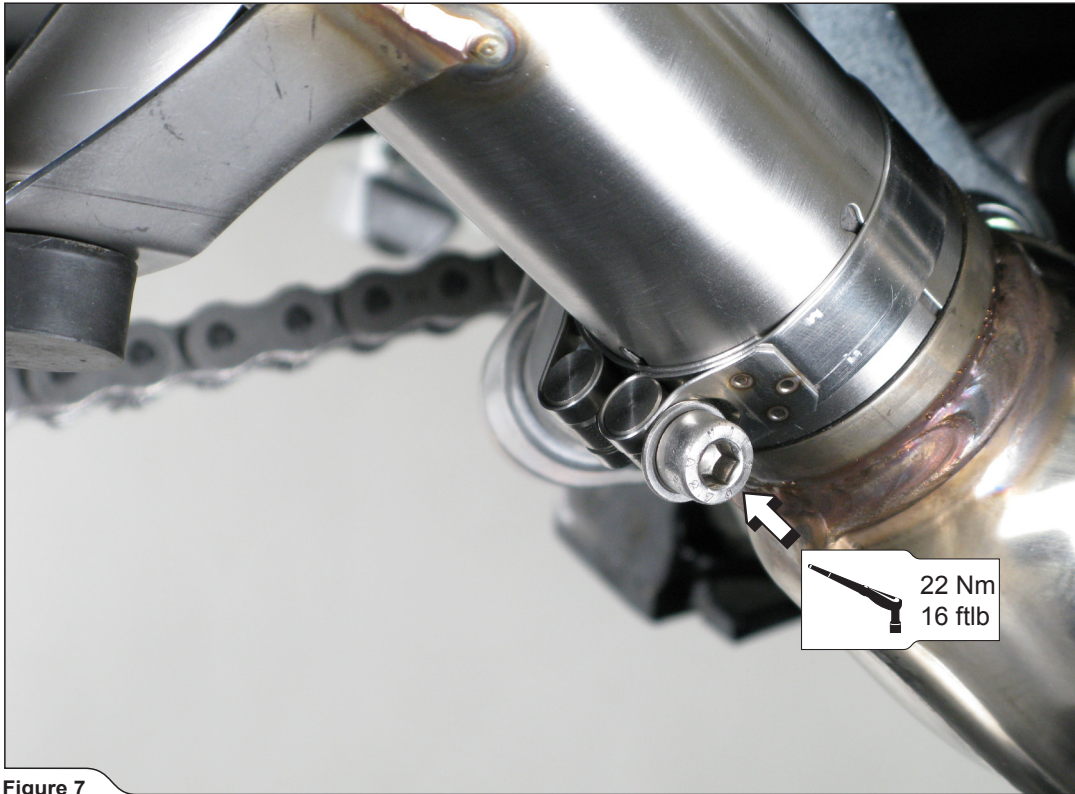

Figure 7

**Final installation:**

Clean grease spots:

- a. Muffler – carbon-fiber outlet cap: use a soft dry cloth.
- b. Muffler – titanium outer sleeve: use a soft cloth sprayed with a multi-purpose spray lubricant (WD-40 or equivalent).
- c. Slip-On with stainless steel link pipe: use a soft cloth sprayed with a contact cleaner, then wipe with a soft dry cloth

Cleaning will prevent spots from burning onto the surface. Do not use aggressive chemical cleaners, because they can damage the sticker.

**! WARNING: make sure all the bolts are sufficiently tightened. In case the exhaust system touches the cowling or other parts repeat the adjustment of the exhaust system or contact your authorized dealer.**

**! WARNING: check vehicle manufacturer manual for tightening torques (for dismantled stock parts)!**

**! IT IS NORMAL IF WHITE SMOKE COMES OUT OF THE MUFFLER ON FIRST OPERATION.**

**! DO NOT STAND BEHIND THE MUFFLER ON FIRST OPERATION.**

**! DO NOT USE AUTOMOTIVE WHEEL CLEANERS OR ANY CLEANING PRODUCTS WHICH CONTAIN ACIDIC ADDITIVES TO CLEAN AKRAPOVIČ EXHAUST SYSTEMS.**

**MAINTENANCE OF THE AKRAPOVIČ EXHAUST SYSTEM:**

1. Clean the titanium exhaust components with a multi-purpose spray lubricant (WD-40 or equivalent), carbon fiber exhaust components with soft and dry cloth and stainless steel components with soft cloth sprayed with contact cleaner, then wipe with soft and dry cloth. A change in the color of the exhaust system is normal due to the high temperatures.
2. Periodically make sure all the bolts and springs are sufficiently tight.



SUZUKI GSX 1250F&FA / SLIP ON exhaust system / STREET LEGAL / model year: 2010  
 SUZUKI GSF 650 Bandit/ SLIP ON exhaust system / STREET LEGAL / model year: 2009-2010

Product code: S-S12SO4-HRT

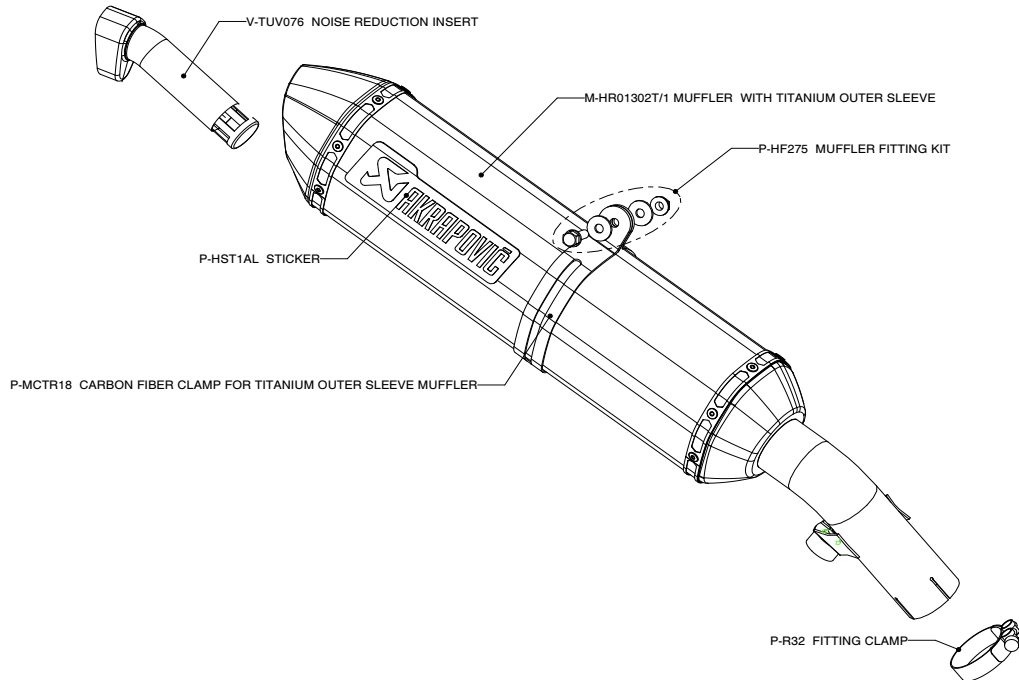

SUZUKI GSF650 Bandit/ SLIP ON exhaust system, model year: 2007-2008/ STREET LEGAL  
 GSF1250 Bandit/ SLIP ON exhaust system, model year: 2007-2010/ STREET LEGAL  
 GSX650F/ SLIP ON exhaust system, model year: 2008-2010/ STREET LEGAL

Product code: S-S12SO3-HRC  
 S-S12SO3-HRT

