



Installation instructions:

AKRAPOVIC SLIP-ON, SLIP-ON with optional link-pipe & SLIP-ON street legal EXHAUST SYSTEMS

for the KAWASAKI ZX-10R (2008)

Congratulations on purchasing an Akrapovic exhaust system. Please read these installation instructions carefully. If you have any trouble installing the system please contact your authorized dealer!

IMPORTANT INFORMATION

Exclusion of Certain Liability

1. The manufacturer, importer or dealer shall not be liable for any incidental damage including personal injury or any other damages caused by improper installation or operation of the Akrapovic exhaust system. When installing the Akrapovic exhaust system be careful that the exhaust system does not touch other parts sensitive to high temperature.
2. Akrapovic makes no representation or warranties with regard to damage caused by the improper installation, use and maintenance of the Akrapovic exhaust system. The warranty is limited to defects recognized by our technical department and to normal use, and excludes items subject to normal wear (gaskets and damping wool). The guarantee is void in case of accident, modification, improper or competition use.
3. Do not attempt to install the Akrapovic exhaust system on a motorcycle for which it was not made or tested by Akrapovic.
4. When the exhaust system gets very hot during operation, be careful not to burn yourself on the exhaust system or parts which are in direct contact with it, even when the motor is not running. Also protect other people, especially children, from the injuries mentioned above.
5. In some cases Akrapovic exhaust system kits contain chemical products (ceramic anti-seizing grease; bolt sealant). Handle with care, do not inhale or swallow. Avoid excessive contact with skin, eyes or mucous membranes. Keep out of reach of children.
6. Technical specifications of Akrapovic exhaust systems and related products subject to change without notice.

Trademarks

The Akrapovic Exhaust System Technology logo is a registered trademark of Akrapovic d.d.

Akrapovic website

Information about Akrapovic exhaust systems and related products is available on the Akrapovic website at:

<http://www.akrapovic.com/>

Copyright

No part of the Akrapovic exhaust system or its documentation may be reproduced or distributed in any form or by any means without the prior written authorization of the Akrapovic company.

© Akrapovic, d.d. All rights reserved.

Symbols

The following symbols are used throughout these installation instructions:



USE BOLT SEALANT; Apply 3 to 4 small drops of bolt sealant onto the cleaned and degreased threads before tightening bolts. **WARNING! Avoid contact with skin, eyes and mucous membranes. Do not inhale fumes. Keep out of the reach of children.**



USE ANTI-SEIZING GREASE (white tube); Prevents seizing, corrosion and excessive wear between the titanium components of your exhaust system. **WARNING! Avoid eye contact. Avoid excessive skin contact. Keep out of the reach of children.**



USE ANTI-SEIZE LEAD-FREE COPPER PASTE (black tube); Provides trouble-free and long-lasting protection against seizing, corrosion and rusting of bolts, threaded ends, nuts, joints, etc. Also protects against vibration, wear and impact. **WARNING! Avoid eye contact. Avoid excessive skin contact. Keep out of the reach of children.**

INSTALLATION INSTRUCTIONS

 BEFORE INSTALLING CHECK SCHEMATIC OF THE EXHAUST SYSTEM!

 IF ANY ITEMS IN THE AKRAPOVIC EXHAUST SYSTEM PACKAGE ARE MISSING PLEASE CONTACT YOUR AUTHORIZED DEALER. KEEP THE SCHEMATIC FOR FUTURE REFERENCE.

 THESE INSTALLATION INSTRUCTIONS MUST BE READ CAREFULLY IN ORDER TO ENSURE PROPER INSTALLATION AND OPERATION OF THE AKRAPOVIC EXHAUST SYSTEM.

 THE EXHAUST SYSTEM CAN BE EXTREMELY HOT. ALLOW THE MOTORCYCLE TO COOL DOWN BEFORE BEGINNING INSTALLATION.

 WE ADVISE YOU TO LEAVE INSTALLATION TO A QUALIFIED SERVICEMAN. IMPROPER INSTALLATION MAY RESULT IN A SHORTER LIFETIME OF THE EXHAUST SYSTEM AND/OR DAMAGE TO THE MOTORCYCLE.



T-handle 10mm wrench
T-handle 12mm wrench
T-handle 3mm three hexagon key wrench
T-handle 4mm three hexagon key wrench
T-handle 5mm three hexagon key wrench
Combination 8mm wrench (2x)
Combination 12mm wrench
Combination 13mm wrench
Spring puller
Small flat screw

REMOVAL OF STOCK EXHAUST SYSTEM:

1. Put the motorcycle on a side stand, we recommend a racing stand. Make sure, that surface is solid and flat.
2. Unscrew and remove fuel tank side panels and riders seat (Figure 1, 2, 3, 4).



Figure 1



Figure 2



Figure 3



Figure 4

3. Slide the rubber protection of the cable adjusters (Figure 5). **WARNING!** measure (Figure 6) or mark the distance on both adjusters so you can adjust them after installation of Akrapovic exhaust system! Shorten the adjusters and loosen the nuts (Figure 7, 8). Remove the safety pin and cables from the exhaust valve servo motor (Figure 9, 10, 11, 12). **WARNING!** do not turn the servo motor wheel with force (only by ignition key switching!) or the servo motor could be damaged.



Figure 5



Figure 6

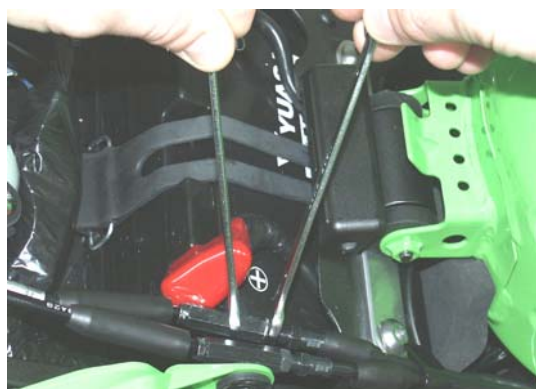

Figure 7



Figure 8



Figure 9



Figure 10



Figure 11



Figure 12

4. Unscrew the bolts from the metal clamp at the muffler - catalytic converter box joint and muffler sub-frame bracket. Remove the muffler together with exhaust valve cables (Figure 13, 14, 15). **WARNING!** be carefull not to damage the cables or any other part of the motorcycle during removal!



Figure 13



Figure 14



Figure 15

5. **For SLIP-ON with optional link-pipe only:** unscrew and remove the stock heatshield (**Figure 16**). Unscrew the bolt from the metal clamp from the catalytic converter box – header tube set joint (**Figure 17**). Unscrew the bolts from the catalytic converter box brackets and remove the catalytic converter box (**Figure 18, 19**).



Figure 16



Figure 17



Figure 18



Figure 19

INSTALLATION OF THE AKRAPOVIC SLIP-ON EXHAUST SYSTEM:

1. **For SLIP-ON with optional link-pipe only:** Install graphite sleeve gasket into the link pipe (**Figure 20**). Coat the bolts and interior of both metal clamps with Akrapovic anti-seize lead-free copper paste (black tube) and correctly install the metal clamps onto the link pipe (**Figure 21, 22, 23**).



Figure 20



Figure 21

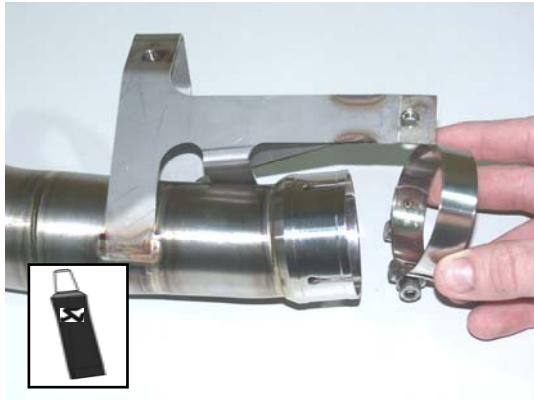

Figure 22



Figure 23

2. For SLIP-ON with optional link-pipe only: slide the optional link pipe onto the stock collector and tighten the bolt of link-pipe bracket-frame joint (Figure 24, 25).



Figure 24

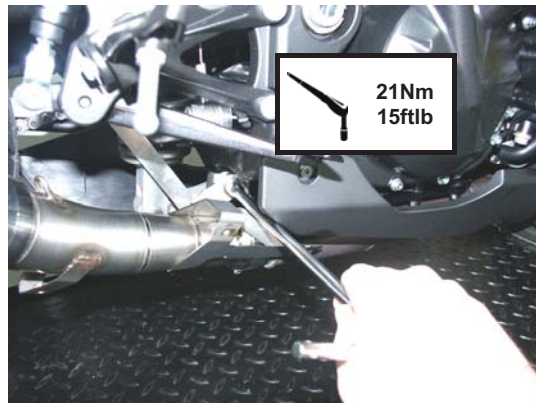

Figure 25

3. For SLIP-ON with optional link-pipe only: tighten the lower metal clamp and reinstall the stock heatshield using stock bolts and washers (Figure 26, 27).

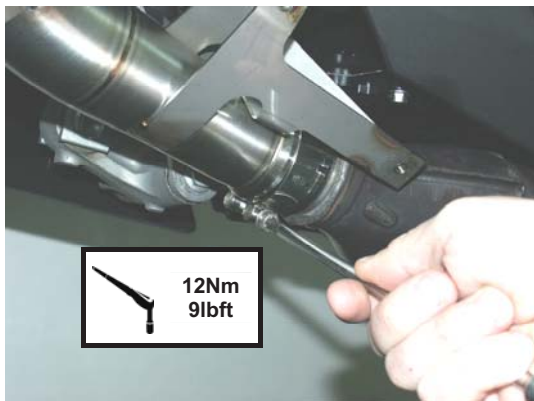

Figure 26

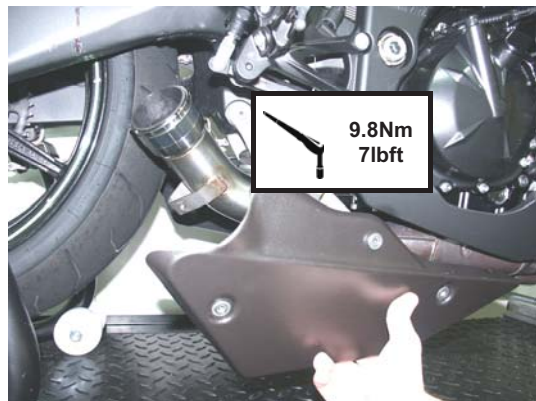

Figure 27

4. **For SLIP-ON (without optional link-pipe!) only:** remove stock graphite sleeve gasket and replace it with Akrapovic graphite sleeve gasket (Figure 28, 29).



Figure 28



Figure 29

5. **For SLIP-ON (without optional link-pipe!) only:** correctly install clamp with hook for spring (Figure 30, 31).



Figure 30

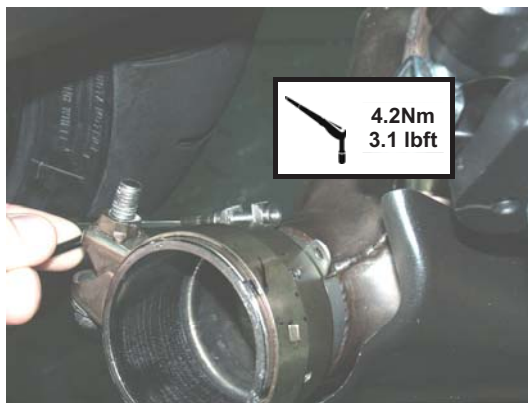

Figure 31

6. **For street legal SLIP-ON (with exhaust valve) only:** remove the valve guard and both cables from the stock exhaust valve (Figure 32, 33, 34). Reinstall the cables and valve guard onto the Akrapovic exhaust valve and stock servo motor in the reverse order from the order in which they were removed (Figure 35, 36, 37, 38, 39). **CAUTION!** use additional Akrapovic washers and stock bolts for attaching the valve guard (Figure 36).



Figure 32



Figure 33



Figure 34

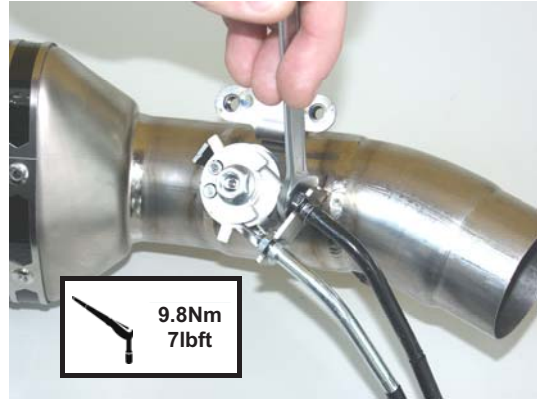

Figure 35

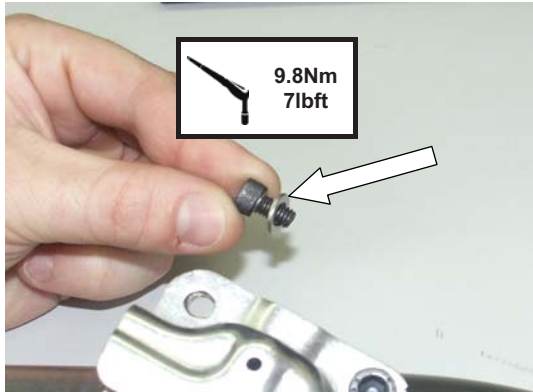

Figure 36



Figure 37



Figure 38



Figure 39

7. Adjust the cable adjusters to original position, tighten the nuts and slide the rubber protection over adjusters (Figure 40, 41, 42).



Figure 40

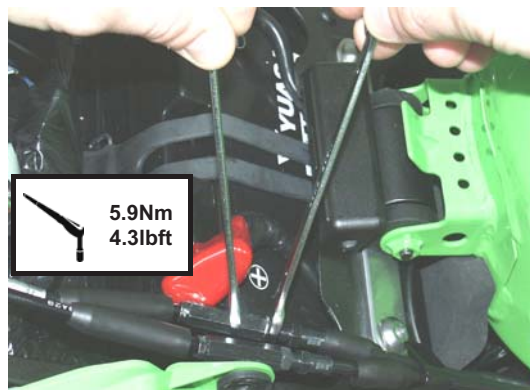

Figure 41



Figure 42

8. Correctly position the carbon-fiber clamp and slide it onto the muffler - bear in mind the left offset of the carbon-fiber clamp viewed from the rear. **WARNING!** open the clamp slightly wider than the diameter of the outer sleeve of the muffler – do not scrape it along the muffler outer sleeve! (Figure 43).



Figure 43

9. Position the muffler with welded link-pipe correctly, slide it into the outlet side of the link pipe (or catalytic converter box outlet) and attach the spring (**Figure 44, 45**). Attach the carbon-fiber clamp onto muffler bracket using stock bolt, nut and Akrapovic washer as shown in figures (**Figure 46, 47, 48**). Tighten the metal clamp of link pipe/collector joint (**Figure 49**). **For SLIP-ON with optional link-pipe only:** Tighten the Akrapovic metal clamp of optional link pipe/link pipe joint (**Figure 50**). Make sure the link pipe or muffler are not touching the swing arm or any other part of the motorcycle.



Figure 44



Figure 45



Figure 46



Figure 47



Figure 48

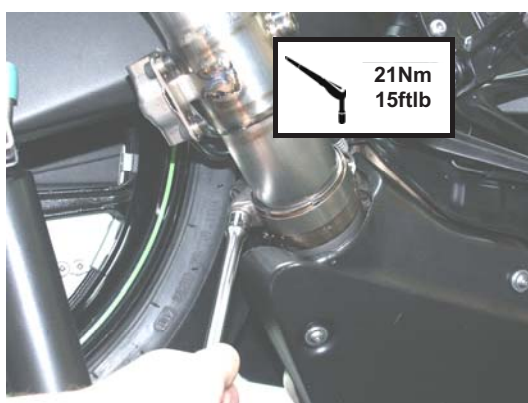

Figure 49

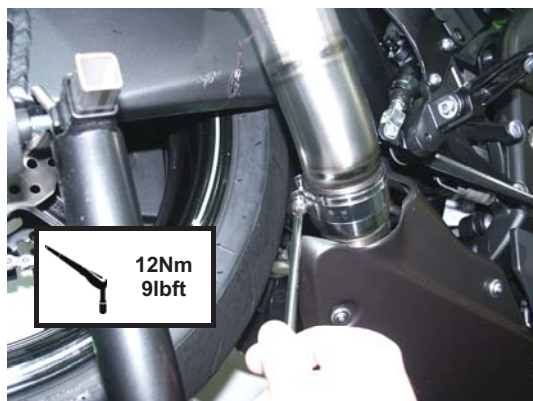

Figure 50

Final installation:

1. Clean grease spots:
 - a. Muffler – carbon-fiber outer sleeve: use a soft dry cloth.
 - b. Muffler – titanium outer sleeve: use a soft cloth sprayed with a multi-purpose spray lubricant (WD-40 or equivalent).
 - c. Muffler – carbon-fiber outlet cap: use a soft dry cloth.
 - d. Stainless steel link pipe: use a soft cloth sprayed with a contact cleaner, then wipe with a soft dry cloth.
 - e. Titanium inlet cap and welded link pipe: use a soft cloth sprayed with a multi-purpose spray lubricant (WD-40 or equivalent).

Cleaning will prevent spots from burning onto the surface. Do not use aggressive chemical cleaners, because they can damage the sticker.

Position of the correctly installed Akrapovic **SLIP-ON** system (Figure 51).



Figure 51

2. Check the operation of the brakes and suspension. Make sure all the bolts are sufficiently tightened. In case the exhaust system touches the cowling or other parts repeat the adjustment of the exhaust system or contact your authorized dealer.

! IT IS NORMAL IF WHITE SMOKE COMES OUT OF THE MUFFLER ON FIRST OPERATION.

! DO NOT STAND BEHIND THE MUFFLER ON FIRST OPERATION.

! DO NOT USE AUTOMOTIVE WHEEL CLEANERS OR ANY CLEANING PRODUCTS WHICH CONTAIN ACIDIC ADDITIVES TO CLEAN AKRAPOVIC EXHAUST SYSTEMS.

MAINTENANCE OF THE AKRAPOVIC EXHAUST SYSTEM

1. Clean the titanium exhaust components with a multi-purpose spray lubricant (WD-40 or equivalent), carbon fiber exhaust components with soft and dry cloth and stainless steel components with soft cloth sprayed with contact cleaner, then wipe with soft and dry cloth. Do not use aggressive chemical cleaners, because they can damage the sticker. A change in the color of the exhaust system is normal due to the high temperatures.
2. The wearing out of the muffler silencing material depends on the type of the engine and riding style. Contact your dealer/serviceman if visible changes appear on muffler's outer sleeve or the noise level is increased.
3. Periodically make sure all the bolts and springs are sufficiently tight.

Kawasaki ZX-10R Slip-on exhaust system, model year 2008
Product code: S-K10SO4-ZC
S-K10SO4-ZT

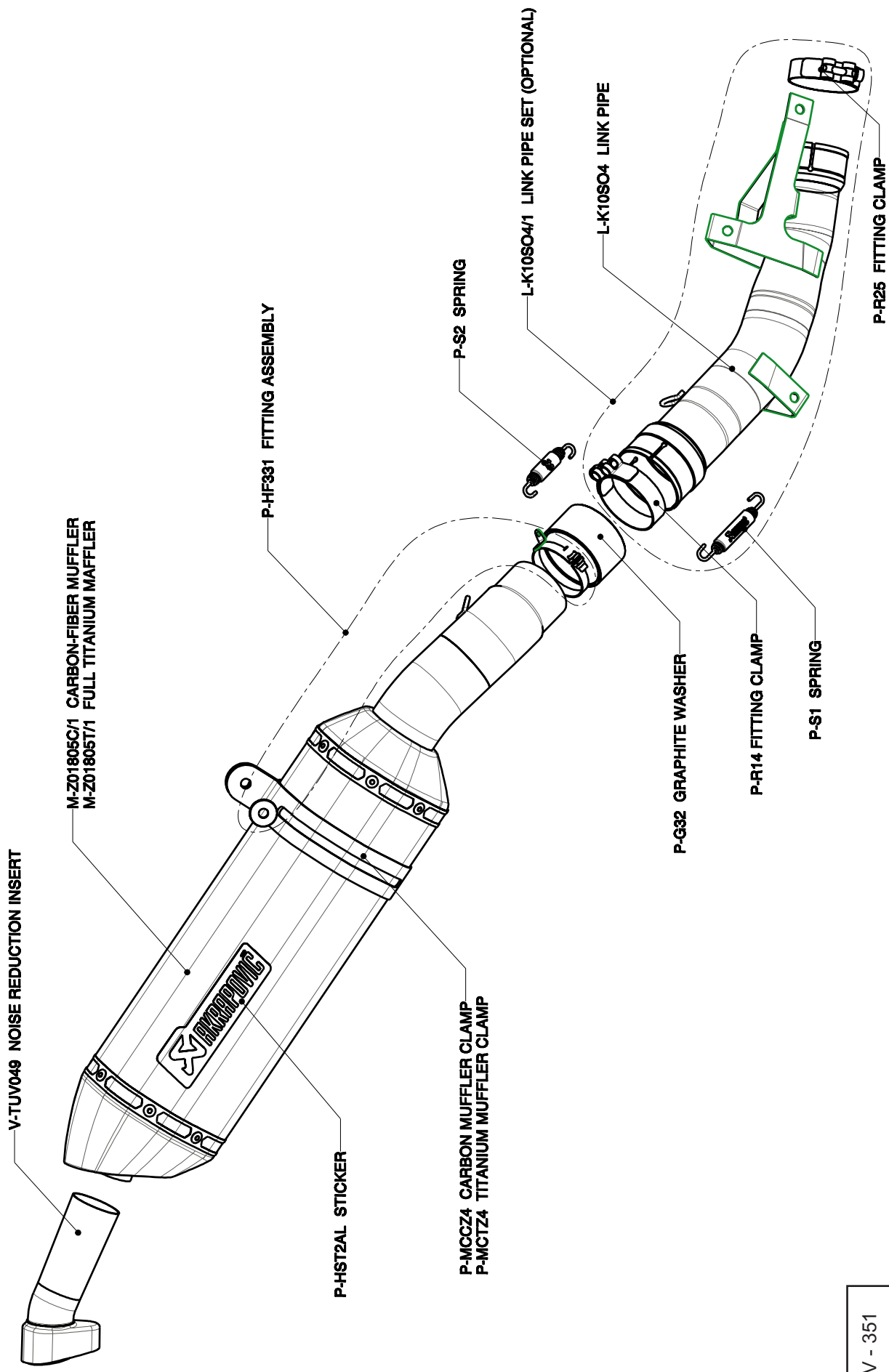

Kawasaki ZX-10R/ Slip-on exhaust system/STREET LEGAL/ model year: 2008
Product code: S-K10SO4-HZC
S-K10SO4-HZT

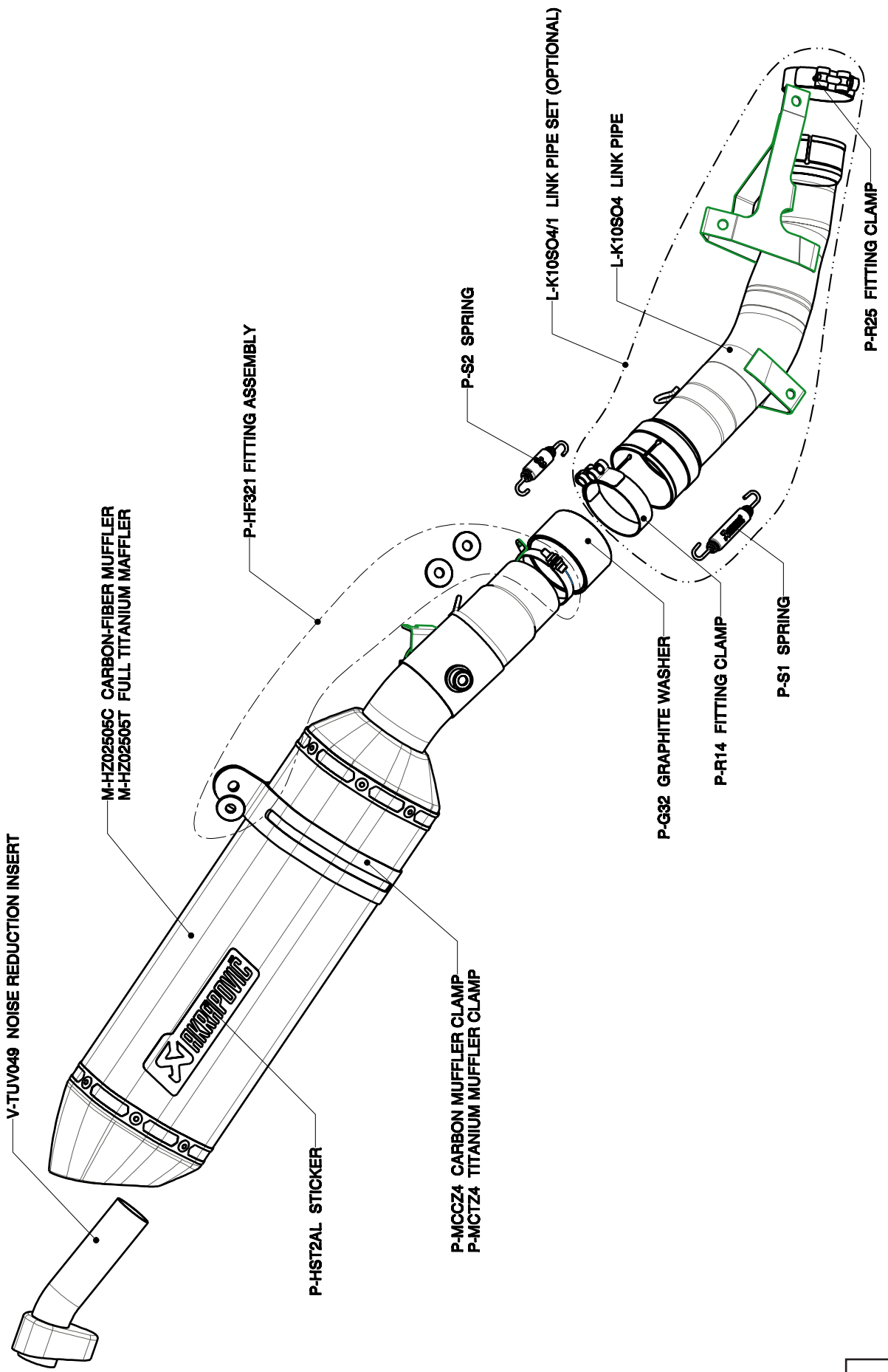

KAWASAKI ZX-10R /RACING LINE tube set with Street legal SLIP ON Mufflers ,Model year 2008

Product code: S-K10R5-ZC/1
S-K10R5-ZT/1

WARNING! IN CASE OF COMBINATION WITH RACING TUBE SET THE SLIP-ON HOMOLOGATION IS NOT VALID!

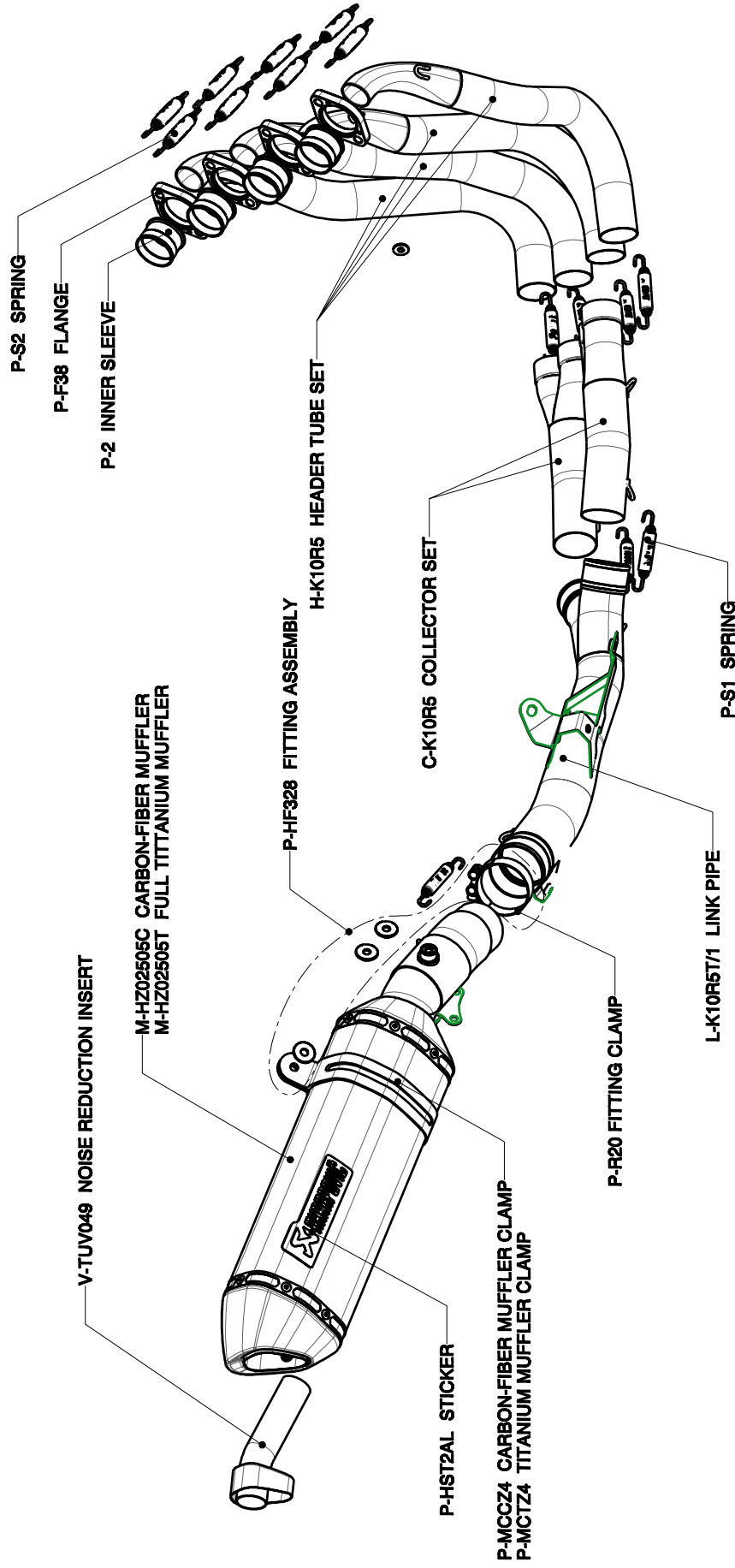

KAWASAKI ZX-10R /EVOLUTION LINE tube set with Street legal SLIP ON Mufflers ,Model year 2008

Product code: S-K10RFT5T-ZC/1
S-K10RFT5T-ZT/1

WARNING! IN CASE OF COMBINATION WITH EVOLUTION TUBE SET THE SLIP-ON HOMOLOGATION IS NOT VALID!

