

Installation instructions:



AKRAPOVIC SLIP-ON SP SERIES EXHAUST SYSTEM for the HONDA CBR1100XX (2004 - 2006)

Congratulations on purchasing an Akrapovic exhaust system. Please read these installation instructions carefully. If you have any trouble installing the system please contact your authorized dealer!

IMPORTANT INFORMATION

Exclusion of Certain Liability

1. The manufacturer, importer or dealer shall not be liable for any incidental damage including personal injury or any other damages caused by improper installation or operation of the Akrapovic exhaust system. When installing the Akrapovic exhaust system be careful that the exhaust system does not touch other parts sensitive to high temperature.
2. Akrapovic makes no representation or warranties with regard to damage caused by the improper installation, use and maintenance of the Akrapovic exhaust system. The warranty is limited to defects recognized by our technical department and to normal use, and excludes items subject to normal wear (gaskets and damping wool). The guarantee is void in case of accident, modification, improper or competition use.
3. Do not attempt to install the Akrapovic exhaust system on a motorcycle for which it was not made or tested by Akrapovic.
4. When the exhaust system gets very hot during operation, be careful not to burn yourself on the exhaust system or parts which are in direct contact with it, even when the motor is not running. Also protect other people, especially children, from the injuries mentioned above.
5. In some cases Akrapovic exhaust system kits contain chemical products (ceramic anti-seizing grease; bolt sealant). Handle with care, do not inhale or swallow. Avoid excessive contact with skin, eyes or mucous membranes. Keep out of reach of children.
6. Technical specifications of Akrapovic exhaust systems and related products subject to change without notice.

Trademarks

The Akrapovic Exhaust System Technology logo is a registered trademark of Akrapovic d.å.

Akrpovic website

Information about Akrapovic exhaust systems and related products is available on the Akrapovic website at:
<http://www.akrapovic-exhaust.com/>

Copyright

No part of the Akrapovic exhaust system or its documentation may be reproduced or distributed in any form or by any means without the prior written authorization of the Akrapovic company.

© Akrapovic d.å. All rights reserved.





Symbols

The following symbols are used throughout these installation instructions:

! CAUTION OR WARNING

 INSTALLATION TIP

INSTALLATION INSTRUCTIONS

- | |
|---|
|  BEFORE INSTALLING CHECK SCHEMATIC OF THE EXHAUST SYSTEM! |
|  IF ANY ITEMS IN THE AKRAPOVIC EXHAUST SYSTEM PACKAGE ARE MISSING PLEASE CONTACT YOUR AUTHORIZED DEALER. KEEP THE SCHEMATIC FOR FUTURE REFERENCE. |
|  THESE INSTALLATION INSTRUCTIONS MUST BE READ CAREFULLY IN ORDER TO ENSURE PROPER INSTALLATION AND OPERATION OF THE AKRAPOVIC EXHAUST SYSTEM. |
|  THE EXHAUST SYSTEM CAN BE EXTREMELY HOT. ALLOW THE MOTORCYCLE TO COOL DOWN BEFORE BEGINNING INSTALLATION. |
|  WE ADVISE YOU TO LEAVE INSTALLATION TO A QUALIFIED SERVICEMAN. IMPROPER INSTALLATION MAY RESULT IN A SHORTER LIFETIME OF THE EXHAUST SYSTEM AND/OR DAMAGE TO THE MOTORCYCLE. |

REMOVAL OF STOCK EXHAUST SYSTEM

1. put the motorcycle on a central stand, we recommend a racing stand
2. remove the bolt from the muffler metal bracket, unscrew the bolt from the metal clamp at the link pipe - collector joint (both sides of the motorcycle) (**Figure 1, 2**)
3. remove the bolt from the link pipe – frame bracket (both sides of the motorcycle) (**Figure 3**)
4. unscrew the bolts from the rider's footrest bracket (both sides of the motorcycle) – do not disconnect the brake fluid tube! (**Figure 4, 5**)
5. partially rotate and pull mufflers of the both sides of the motorcycle (**Figure 6**)
6. remove the rubber vibration dampers and sleeves from the stock **link pipe** chassis hanging bracket (both sides of the motorcycle) (**Figure 7**)
7. reattach the rider's footrest bracket (both sides of the motorcycle) (**Figure 8, 9**)

INSTALLATION OF THE AKRAPOVIC SLIP-ON SP SERIES EXHAUST SYSTEM

installing the independent link pipe:

1. correctly install the metal clamp onto the inlet sleeve of the link pipe (both sides of the motorcycle)
2. slide the link pipe (inlet side) onto the collector (both sides of the motorcycle) (**Figure 10**)
3. make sure the link pipe is not touching the frame and other parts



installing the muffler:

1. position the muffler correctly and slide it onto the outlet side of the link pipe (both sides of the motorcycle) (**Figure 11**)
2. position and attach the springs (both sides of the motorcycle) (**Figure 12**)
3. correctly position the carbon-fiber clamp and slide it onto the muffler - bear in mind the left offset for the right muffler and right offset for the left muffler of the carbon-fiber clamp viewed from the rear. **WARNING:** open the clamp to slightly wider than the diameter of the outer sleeve of the muffler – do not scrape it along the muffler outer sleeve! (**Figure 13**)
4. tighten the carbon-fiber clamp onto the stock chassis hanging bracket on the frame (both sides of the motorcycle) (**Figure 14**)
5. make sure the mufflers are not touching other parts of the motorcycle

final installation:

1. tighten the bolts on all of the brackets and clamps to which the exhaust system and the other dismantled parts of the motorcycle are attached
2. position of the installed Akrapovic Slip-on SP SERIES system (**Figure 15**)
3. clean grease spots:
 - a. muffler – titanium outer sleeve: use a soft cloth sprayed with a multi-purpose spray lubricant (WD-40 or equivalent)
 - b. stainless steel link pipe: use a soft cloth sprayed with a contact cleaner, then wipe with a soft dry clothCleaning will prevent spots from burning onto the surface. Do not use aggressive chemical cleaners, because they can damage the sticker.

Check the operation of the brakes and suspension. Make sure all the bolts are sufficiently tightened. In case the exhaust system touches the cowling or other parts repeat the adjustment of the exhaust system or contact your authorized dealer.

- | |
|---|
|  IT IS NORMAL IF WHITE SMOKE COMES OUT OF THE MUFFLER ON FIRST OPERATION. |
|  DO NOT STAND BEHIND THE MUFFLER ON FIRST OPERATION. |
|  DO NOT USE AUTOMOTIVE WHEEL CLEANERS OR ANY CLEANING PRODUCTS WHICH CONTAIN ACIDIC ADDITIVES TO CLEAN AKRAPOVIC EXHAUST SYSTEMS. |

MAINTENANCE OF THE AKRAPOVIC EXHAUST SYSTEM

1. Clean the titanium muffler outer sleeve with a multi-purpose spray lubricant (WD-40 or equivalent). Do not use aggressive chemical cleaners, because they can damage the sticker. A change in the color of the exhaust system is normal due to the high temperatures.
2. The wearing out of the muffler silencing material depends on the type of the motor and riding style. Contact your dealer/serviceman if visible changes appear on muffler's outer sleeve or the noise level is increased.

3. Periodically ensure that all the bolts and springs are sufficiently tight.

Photos:



Figure 1



Figure 2

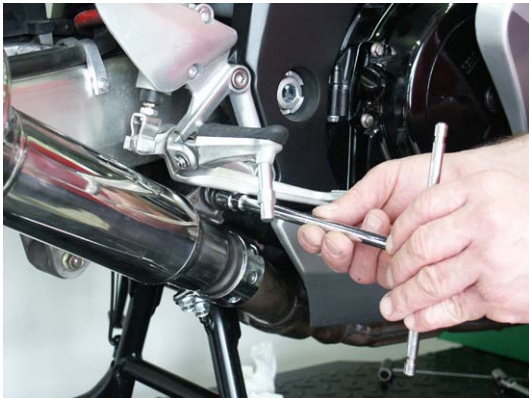

Figure 3



Figure 4



Figure 5



Figure 6



Figure 7



Figure 8



Figure 9



Figure 10



Figure 11



Figure 12



Figure 13



Figure 14



Figure 15

Honda CBR 1100XX, Slip-on exhaust system/ model year:2004-2006 / OPEN/ SP-SERIES

**Product code: 106030 (SS-H11SO2-C)
106032 (SS-H11SO2-T)**

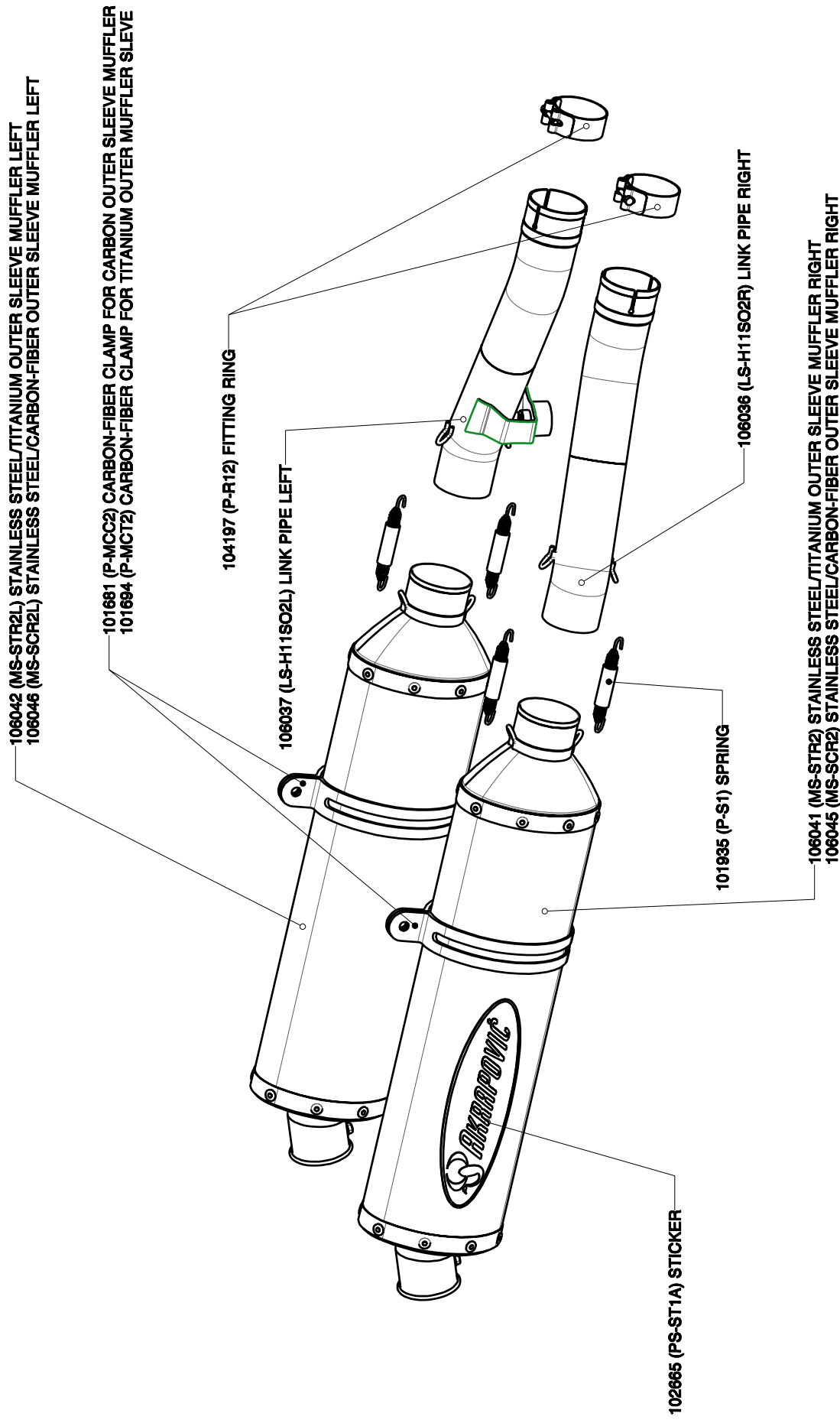

Honda CBR 1100 XX 2004 - 2006 / Slip-on line SP series / STREET LEGAL

Product code: 106034 (SS-H11SO2-HC)
106033 (SS-H11SO2-HT)

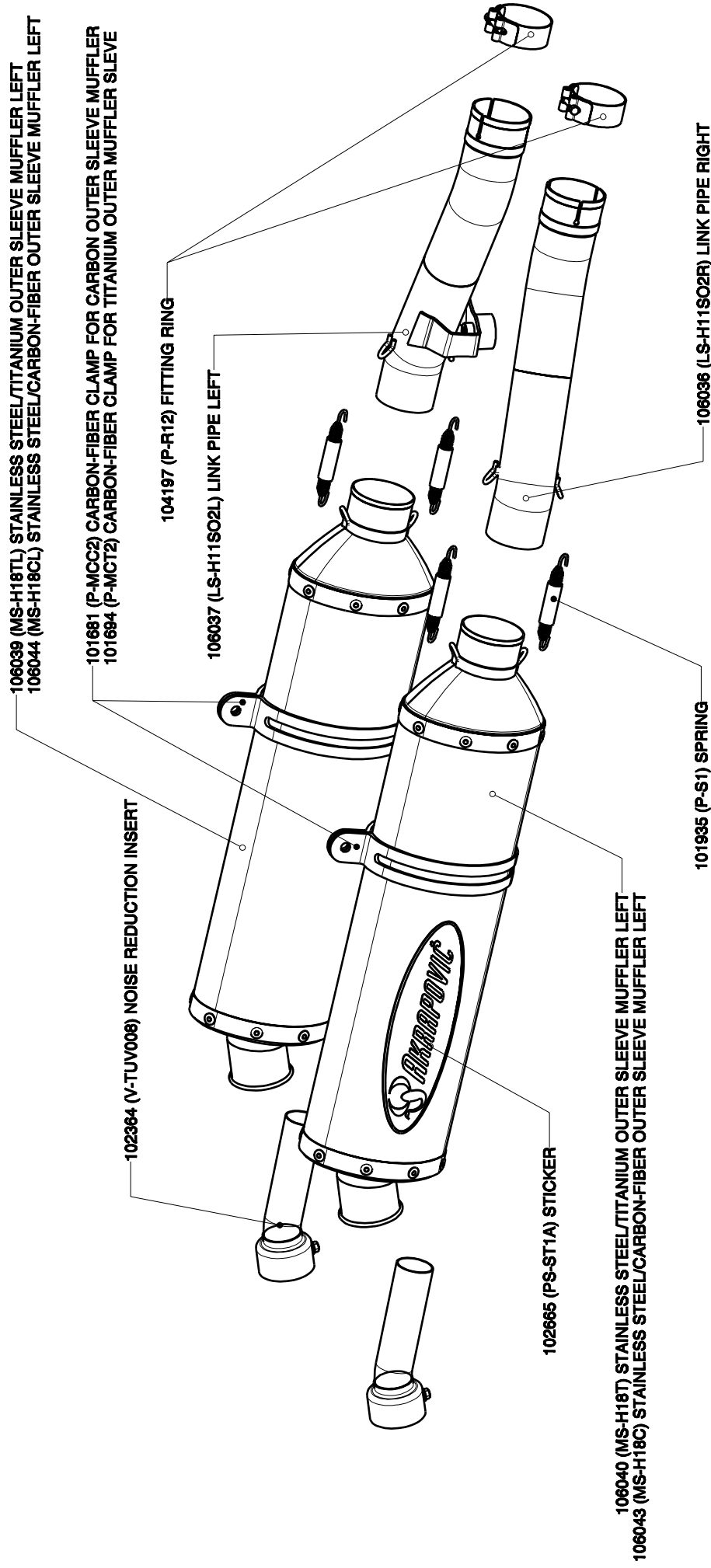

WARNING:

Please note that certain aftermarket exhaust systems may not comply with applicable California laws and regulations, and may therefore be prohibited for use on California highways or roads, or on roads or vehicles otherwise subject to emissions control requirements.

Akrapovič exhaust systems for automobiles and motorcycles mounted downstream of the catalytic converter (also known as “cat-back systems”) are considered “replacement parts” in California by the California Air Resources Board (CARB), and do not require an exemption or executive order from CARB to be sold in California. However, California prohibits the use of any aftermarket exhaust system that modifies, removes or replaces original equipment catalysts, unless CARB has issued an Executive Order as to such part or system.

Further, Akrapovič parts or exhaust systems used or intended for use on “racing vehicles” (i.e. a competition vehicle used exclusively for competition on closed-course circuits) do not require an exemption or Executive Order from CARB to be sold in California. However, such parts are prohibited from use on California public highways or roads, even if occasionally used “off-road.”