

## **Installation instructions:**



# **AKRAPOVIC SLIP-ON & SLIP-ON STREET LEGAL EXHAUST SYSTEM for the HONDA CBR 1000 RR (2004)**

**Congratulations on purchasing an Akrapovic exhaust system. Please read these installation instructions carefully. If you have any trouble installing the system please contact your authorized dealer!**

### **IMPORTANT INFORMATION**

#### **Exclusion of Certain Liability**

1. The manufacturer, importer or dealer shall not be liable for any incidental damage including personal injury or any other damages caused by improper installation or operation of the Akrapovic exhaust system. When installing the Akrapovic exhaust system be careful that the exhaust system does not touch other parts sensitive to high temperature.
2. Akrapovic makes no representation or warranties with regard to damage caused by the improper installation, use and maintenance of the Akrapovic exhaust system. The warranty is limited to defects recognized by our technical department and to normal use, and excludes items subject to normal wear (gaskets and damping wool). The guarantee is void in case of accident, modification, improper or competition use.
3. Do not attempt to install the Akrapovic exhaust system on a motorcycle for which it was not made or tested by Akrapovic.
4. When the exhaust system gets very hot during operation, be careful not to burn yourself on the exhaust system or parts which are in direct contact with it, even when the motor is not running. Also protect other people, especially children, from the injuries mentioned above.
5. In some cases Akrapovic exhaust system kits contain chemical products (ceramic anti-seizing grease; bolt sealant). Handle with care, do not inhale or swallow. Avoid excessive contact with skin, eyes or mucous membranes. Keep out of reach of children.
6. Technical specifications of Akrapovic exhaust systems and related products subject to change without notice.

#### **Trademarks**

The Akrapovic Exhaust System Technology logo is a registered trademark of Akrapovic d.â.

#### **Akrapovic website**

Information about Akrapovic exhaust systems and related products is available on the Akrapovic website at:  
**<http://www.akrapovic-exhaust.com/>**

#### **Copyright**

No part of the Akrapovic exhaust system or its documentation may be reproduced or distributed in any form or by any means without the prior written authorization of the Akrapovic company.

© Akrapovic d.â. All rights reserved.

#### **Symbols**

The following symbols are used throughout these installation instructions:



**CAUTION OR WARNING**



**INSTALLATION TIP**


## **INSTALLATION INSTRUCTIONS**

 **BEFORE INSTALLING CHECK SCHEMATIC OF THE EXHAUST SYSTEM!**

**! IF ANY ITEMS IN THE AKRAPOVIC EXHAUST SYSTEM PACKAGE ARE MISSING PLEASE CONTACT YOUR AUTHORIZED DEALER. KEEP THE SCHEMATIC FOR FUTURE REFERENCE.**

**! THESE INSTALLATION INSTRUCTIONS MUST BE READ CAREFULLY IN ORDER TO ENSURE PROPER INSTALLATION AND OPERATION OF THE AKRAPOVIC EXHAUST SYSTEM.**

**! THE EXHAUST SYSTEM CAN BE EXTREMELY HOT. ALLOW THE MOTORCYCLE TO COOL DOWN BEFORE BEGINNING INSTALLATION.**

 **WE ADVISE YOU TO LEAVE INSTALLATION TO A QUALIFIED SERVICEMAN. IMPROPER INSTALLATION MAY RESULT IN A SHORTER LIFETIME OF THE EXHAUST SYSTEM AND/OR DAMAGE TO THE MOTORCYCLE.**

### **REMOVAL OF STOCK EXHAUST SYSTEM**

1. put the motorcycle on a side stand, we recommend a racing stand
2. remove the passenger's and rider's seat (bolts under the seat on both sides) **(Figure 1, 2)**
3. unscrew the bolts from the fastback and remove the fastback; disconnect the electrical leads for the rear light **(Figure 3, 4, 5)**
4. remove the license plate holder and turn signal lamps **(Figure 6, 7)**
5. unscrew the bolts from the cover of the muffler outlet cap **(Figure 8, 9, 10)**
6. remove the plastic leg protector which is above the heat shield – right side of the motorcycle (viewed from the rear) and the passenger's footrest bracket **(Figure 11, 12, 13, 14)**
7. unscrew the bolts from the heat shield, the bolts from the rider's footrest bracket – do not disconnect the brake fluid tube! **(Figure 15, 16, 17)**
8. remove the cover of the servo motor (exup); disconnect and remove the cables on both sides (servo motor an exhaust valve) **(Figure 18, 19, 20, 21, 22)**
9. remove the metal clamp at the muffler link pipe – independent link pipe connection **(Figure 23, 24)**
10. unscrew the bolts from the muffler bracket and remove the muffler **(Figure 25, 26, 27)**
11. remove the metal clamp at the independent link pipe – collector connection and the independent link pipe **(Figure 28, 29)**

### **INSTALLATION OF THE AKRAPOVIC SLIP-ON STREET LEGAL SYSTEM**

#### **installing the independent link pipe:**

1. onto the stock collector properly install the metal ring for attaching the spring **(Figure 30, 31)**
2. install the metal clamp onto the Akrapovic independent link pipe
3. slide the Akrapovic independent link pipe onto the stock collector; do not tighten the metal clamp **(Figure 32)**
4. attach the spring **(Figure 33)**
5. make sure the link pipe is not touching the frame and other parts

#### **installing the muffler:**

1. correctly position the carbon-fiber clamp and slide it onto the muffler. **WARNING:** open the clamp to slightly wider than the diameter of the outer sleeve of the muffler – do not scrape it along the muffler outer sleeve! Do not fully tighten the bolts of the clamp.
2. position the muffler correctly and slide it onto the outlet side of the link pipe **(Figure 34)**
3. position and attach the springs **(Figure 35)**
4. tighten the carbon-fiber clamp onto the stock chassis hanging bracket on the frame (both sides of the motorcycle) **(Figure 36, 37)**
5. tighten the metal clamp at the independent link pipe – stock collector connection **(Figure 38)**
6. tighten the bolts of the carbon-fiber clamp **(Figure 39)**
7. reattach the stock heat shield **(Figure 40, 41)**
8. reattach the rider's and passengers footrest bracket **(Figure 42, 43)**
9. make sure the muffler is not touching other parts of the motorcycle
10. reattach the license plate holder and turn signal lamps **(Figure 44, 45)**
11. reattach the bolt from the cover of the muffler outlet cap; use the Akrapovic alu distance washer **(Figure 46, 47, 48)**
12. reconnect the electrical leads for the rear light and reattach the fastback and both seats **(Figure 49, 50)**

### final installation:

1. tighten the bolts on all of the brackets and clamps to which the exhaust system and the other dismantled parts of the motorcycle are attached
2. clean grease spots:
  - a. muffler – titanium outer sleeve: use a soft cloth sprayed with a multi-purpose spray lubricant (WD-40 or equivalent)
  - b. muffler – carbon-fiber outer sleeve: use a soft dry cloth
  - c. titanium link pipes: use a soft cloth sprayed with a multi-purpose spray lubricant (WD-40 or equivalent)
  - d. stainless steel independent link pipe: use a soft cloth sprayed with a contact cleaner, then wipe with a soft dry cloth

Cleaning will prevent spots from burning onto the surface. Do not use aggressive chemical cleaners, because they can damage the sticker.

3. position of the installed Akrapovic Slip-on exhaust system (**Figure 51**)

**Check the operation of the brakes and suspension. Make sure all the bolts are sufficiently tightened. In case the exhaust system touches the cowling or other parts repeat the adjustment of the exhaust system or contact your authorized dealer.**

**! IT IS NORMAL IF WHITE SMOKE COMES OUT OF THE MUFFLER ON FIRST OPERATION.**

**! DO NOT STAND BEHIND THE MUFFLER ON FIRST OPERATION.**

### MAINTENANCE OF THE AKRAPOVIC EXHAUST SYSTEM

1. Clean the titanium muffler outer sleeve with a multi-purpose spray lubricant (WD-40 or equivalent ) and carbon fiber outer sleeve with soft and dry cloth. Do not use aggressive chemical cleaners, because they can damage the sticker. A change in the color of the exhaust system is normal due to the high temperatures.
2. The wearing out of the muffler silencing material depends on the type of the motor and riding style. Contact your dealer/serviceman if visible changes appear on muffler's outer sleeve or the noise level is increased.
3. Periodically ensure that all the bolts and springs are sufficiently tight.

### Photos:



*Figure 1*



*Figure 2*



*Figure 3*



*Figure 4*



**Figure 5**



**Figure 6**



**Figure 7**



**Figure 8**



**Figure 9**



**Figure 10**



**Figure 11**



**Figure 12**

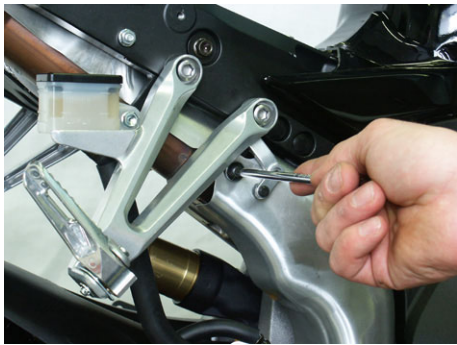




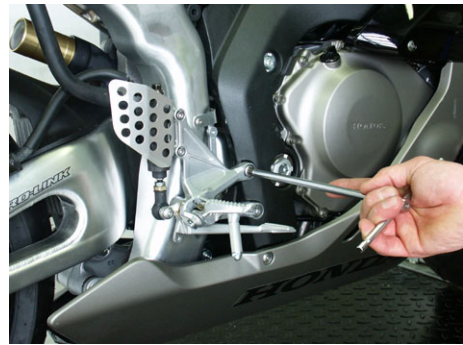
**Figure 13**



**Figure 14**



**Figure 15**



**Figure 16**



**Figure 17**



**Figure 18**



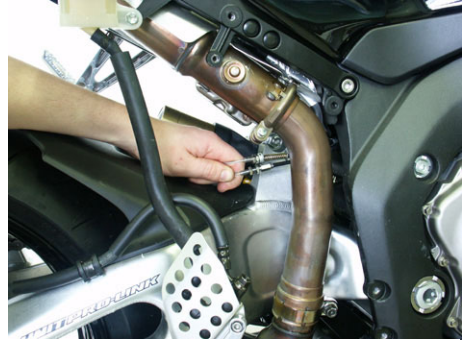
**Figure 19**



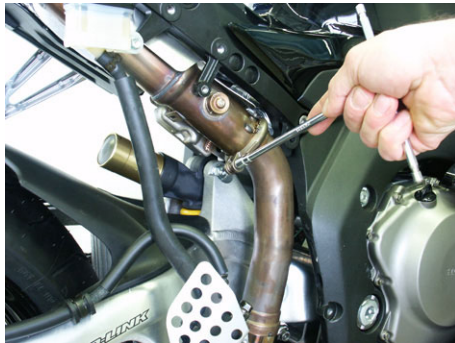
**Figure 20**



**Figure 21**



**Figure 22**



**Figure 23**



**Figure 24**



**Figure 25**



**Figure 26**



**Figure 27**



**Figure 28**





**Figure 29**



**Figure 30**



**Figure 31**



**Figure 32**



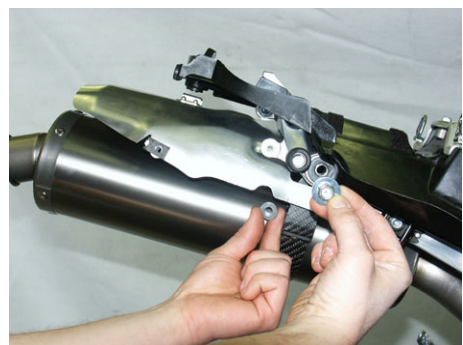
**Figure 33**



**Figure 34**



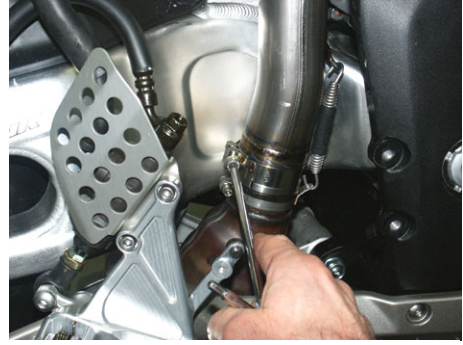
**Figure 35**



**Figure 36**



**Figure 37**



**Figure 38**



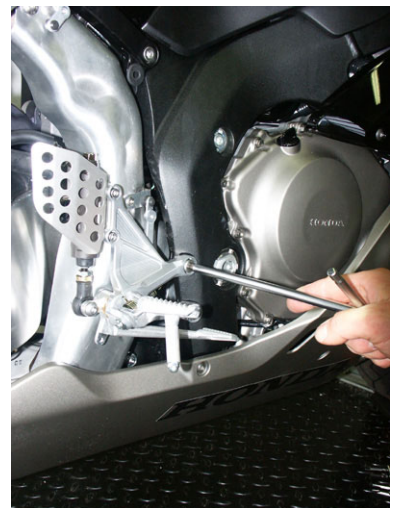
**Figure 39**



**Figure 40**

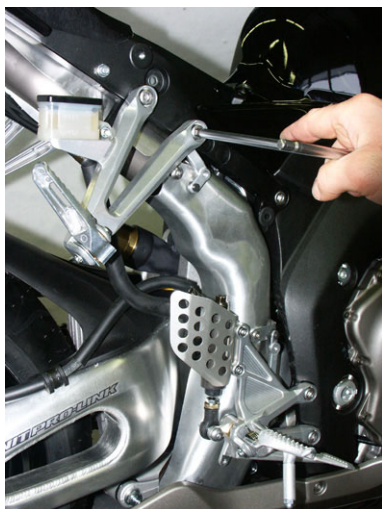


**Figure 41**



**Figure 42**





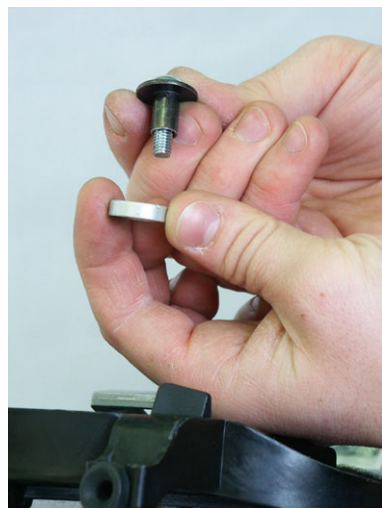
**Figure 43**



**Figure 44**



**Figure 45**



**Figure 46**



**Figure 47**



**Figure 48**



Figure 49

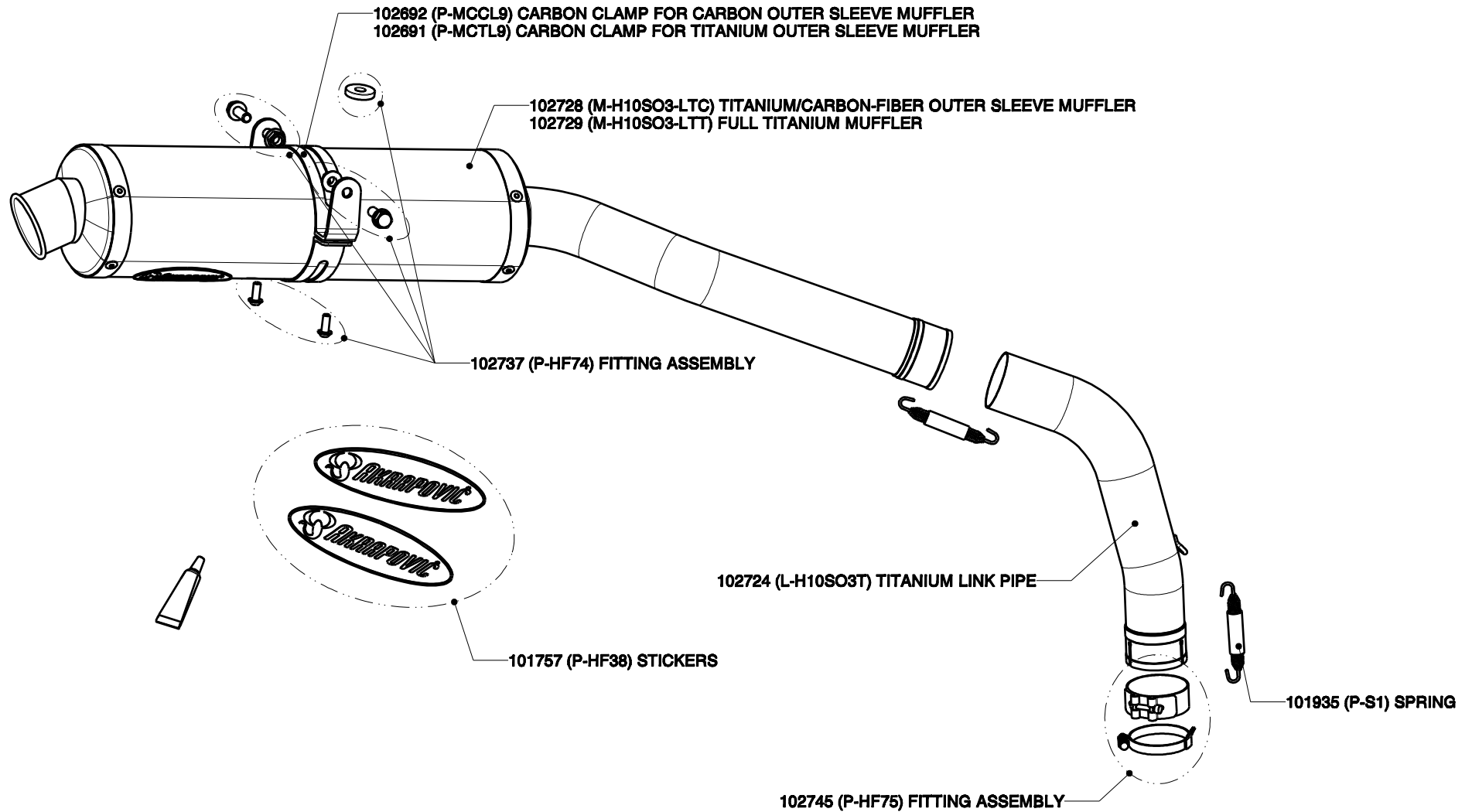


Figure 50



# HONDA CBR 1000RR Slip-on exhaust system. model year:2004

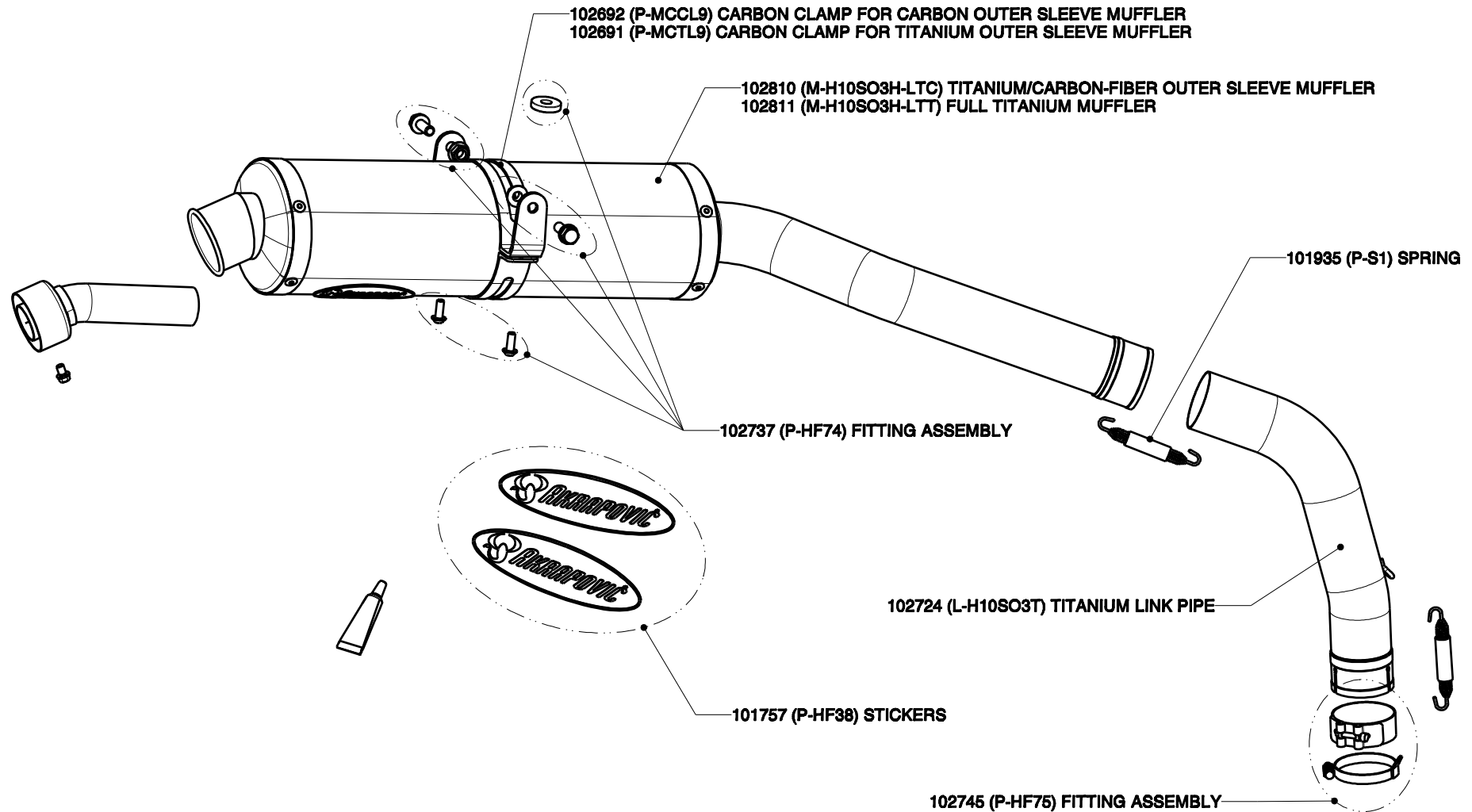
Product code: 102746 (S-H10SO3T-TC)  
102747 (S-H10SO3T-TT)





# HONDA CBR 1000 RR Homologated/Slip-on exhaust system, model year: 2004

Product code: 102843 (S-H10SO3T-HTC)  
102845 (S-H10SO3T-HTT)



**WARNING:**

Please note that certain aftermarket exhaust systems may not comply with applicable California laws and regulations, and may therefore be prohibited for use on California highways or roads, or on roads or vehicles otherwise subject to emissions control requirements.

Akrapovič exhaust systems for automobiles and motorcycles mounted downstream of the catalytic converter (also known as “cat-back systems”) are considered “replacement parts” in California by the California Air Resources Board (CARB), and do not require an exemption or executive order from CARB to be sold in California. However, California prohibits the use of any aftermarket exhaust system that modifies, removes or replaces original equipment catalysts, unless CARB has issued an Executive Order as to such part or system.

Further, Akrapovič parts or exhaust systems used or intended for use on “racing vehicles” (i.e. a competition vehicle used exclusively for competition on closed-course circuits) do not require an exemption or Executive Order from CARB to be sold in California. However, such parts are prohibited from use on California public highways or roads, even if occasionally used “off-road.”