



**AKRAPOVIC SLIP-ON SP SERIES EXHAUST SYSTEM
for the
HONDA CB 600 HORNET (1998 - 2002)**

Congratulations on purchasing an Akrapovic exhaust system. Please read these installation instructions carefully. If you have any trouble installing the system please contact your authorized dealer!

IMPORTANT INFORMATION

Exclusion of Certain Liability

1. The manufacturer, importer or dealer shall not be liable for any incidental damage including personal injury or any other damages caused by improper installation or operation of the Akrapovic exhaust system. When installing the Akrapovic exhaust system be careful that the exhaust system does not touch other parts sensitive to high temperature.
2. Akrapovic makes no representation or warranties with regard to damage caused by the improper installation, use and maintenance of the Akrapovic exhaust system. The warranty is limited to defects recognized by our technical department and to normal use, and excludes items subject to normal wear (gaskets and damping wool). The guarantee is void in case of accident, modification, improper or competition use.
3. Do not attempt to install the Akrapovic exhaust system on a motorcycle for which it was not made or tested by Akrapovic.
4. When the exhaust system gets very hot during operation, be careful not to burn yourself on the exhaust system or parts which are in direct contact with it, even when the motor is not running. Also protect other people, especially children, from the injuries mentioned above.
5. In some cases Akrapovic exhaust system kits contain chemical products (ceramic anti-seizing grease; bolt sealant). Handle with care, do not inhale or swallow. Avoid excessive contact with skin, eyes or mucous membranes. Keep out of reach of children.
6. Technical specifications of Akrapovic exhaust systems and related products subject to change without notice.

Trademarks

The Akrapovic Exhaust System Technology logo is a registered trademark of Akrapovic d.å.

Akrpovic website

Information about Akrapovic exhaust systems and related products is available on the Akrapovic website at:
<http://www.akrapovic-exhaust.com/>

Copyright

No part of the Akrapovic exhaust system or its documentation may be reproduced or distributed in any form or by any means without the prior written authorization of the Akrapovic company.

© Akrapovic d.å. All rights reserved.

Symbols

The following symbols are used throughout these installation instructions:



INSTALLATION INSTRUCTIONS

 **BEFORE INSTALLING CHECK SCHEMATIC OF THE EXHAUST SYSTEM!**

! IF ANY ITEMS IN THE AKRAPOVIC EXHAUST SYSTEM PACKAGE ARE MISSING PLEASE CONTACT YOUR AUTHORIZED DEALER. KEEP THE SCHEMATIC FOR FUTURE REFERENCE.

! THESE INSTALLATION INSTRUCTIONS MUST BE READ CAREFULLY IN ORDER TO ENSURE PROPER INSTALLATION AND OPERATION OF THE AKRAPOVIC EXHAUST SYSTEM.

! THE EXHAUST SYSTEM CAN BE EXTREMELY HOT. ALLOW THE MOTORCYCLE TO COOL DOWN BEFORE BEGINNING INSTALLATION.

 **WE ADVISE YOU TO LEAVE INSTALLATION TO A QUALIFIED SERVICEMAN. IMPROPER INSTALLATION MAY RESULT IN A SHORTER LIFETIME OF THE EXHAUST SYSTEM AND/OR DAMAGE TO THE MOTORCYCLE.**

REMOVAL OF STOCK EXHAUST SYSTEM

1. put the motorcycle on a side stand, we recommend a racing stand
2. remove the plastic covers from the bolts on the rear handle (**Figure 1**), remove the seat (**Figure 2**), remove the bolts from the rear handle and remove the handle (**Figure 3**)
3. remove the right plastic panel (**Figure 4, 5**)
4. remove the bolts from the fastback and lift the fastback (**Figure 6, 7, 8**)
5. disconnect the electrical connectors for the rear lights and remove the fastback (**Figure 9, 10**)
6. unscrew the bolt for the metal clamp on the link pipe (at the link pipe – collector joint) (**Figure 11**)
7. unscrew and remove the bolt for the metal muffler bracket (**Figure 12**)
8. remove the link pipe together with the muffler (link pipe and muffler are welded together). We recommend spraying the joint with a multi-purpose spray lubricant (WD-40 or equivalent)

INSTALLATION OF THE AKRAPOVIC SLIP-ON EXHAUST SYSTEM

installing the link pipe with welded muffler:

1. slide the metal clamp onto the link pipe, making sure that it is oriented correctly so that it can be tightened (**Figure 13**)
2. insert the press-on nuts into the metal brackets on the link pipe (**Figure 14**)
3. insert the bolts into the carbon-fiber heat shield (**Figure 15**), insert the heat washers on the other side (**Figure 16**)
4. correct position of the bolts and heat washers (**Figure 17**) and position of the carbon-fiber heat shield (**Figure 18**)
5. slide the link pipe (inlet side) onto the collector (**Figure 19**)
6. hand tighten the bolt on the metal clamp (**Figure 20**)
7. make sure the link pipe is not touching the frame and other parts
8. correctly position the carbon-fiber clamp and slide it onto the muffler - bear in mind **the left offset** of the carbon-fiber clamp viewed from the rear. **WARNING:** open the clamp to slightly wider than the diameter of the outer sleeve of the muffler – do not scrape it along the muffler outer sleeve! (**Figure 21**)
9. tighten the carbon-fiber clamp onto the stock bracket on the frame – use the stock bolts or the replacements from the Akrapovic kit, if supplied
10. make sure that it is not touching any other parts of the motorcycle
11. re-connect the electrical connectors for the rear lights, replace the fastback and its components (**Figure 22, 23, 24, 25, 26, 27, 28**)
12. check the position of the installed Akrapovic SLIP-ON system (**Figure 29, 30**)

final installation:

1. tighten the bolts on all of the brackets and clamps to which the exhaust system and the other dismantled parts of the motorcycle are attached
2. clean grease spots:
 - a. muffler – titanium outer sleeve: use a soft cloth sprayed with a multi-purpose spray lubricant (WD-40 or equivalent)
 - b. muffler – carbon fiber outer sleeve: use a soft dry cloth
 - c. titanium link pipe: use a soft cloth sprayed with a multi-purpose spray lubricant (WD-40 or equivalent)Cleaning will prevent spots from burning onto the surface. Do not use aggressive chemical cleaners, because they can damage the sticker.
3. replace all of the dismantled stock parts and cowlings in the reverse order from the order in which they were removed
4. **Check the operation of the brakes and suspension. Make sure all the bolts are sufficiently tightened. In case the exhaust system touches the cowling or other parts repeat the adjustment of the exhaust system or contact your authorized dealer.**

! IT IS NORMAL IF WHITE SMOKE COMES OUT OF THE MUFFLER ON FIRST OPERATION.

! DO NOT STAND BEHIND THE MUFFLER ON FIRST OPERATION.

❑ **MAINTENANCE OF THE AKRAPOVIC EXHAUST SYSTEM**

1. Clean the titanium muffler outer sleeve with a multi-purpose spray lubricant (WD-40 or equivalent) and carbon fiber outer sleeve with soft and dry cloth. Do not use aggressive chemical cleaners, because they can damage the sticker.
2. The wearing out of the muffler silencing material depends on the type of the motor and riding style. Contact your dealer/serviceman if visible changes appear on muffler's outer sleeve or the noise level is increased.
3. Periodically make sure all the bolts are sufficiently tight.

Photos:



Figure 1



Figure 2



Figure 3



Figure 4



Figure 5



Figure 6



Figure 7



Figure 8

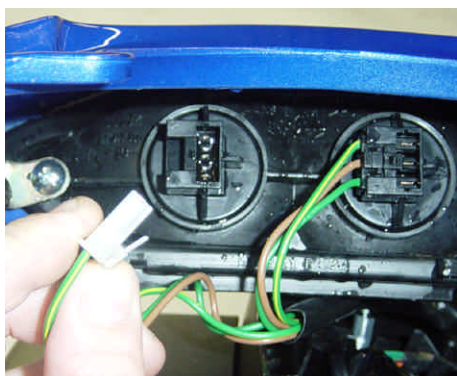

Figure 9



Figure 10

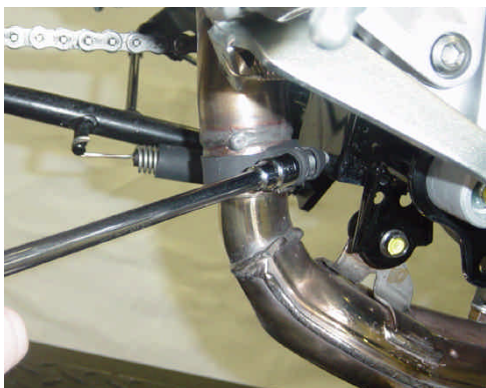

Figure 11

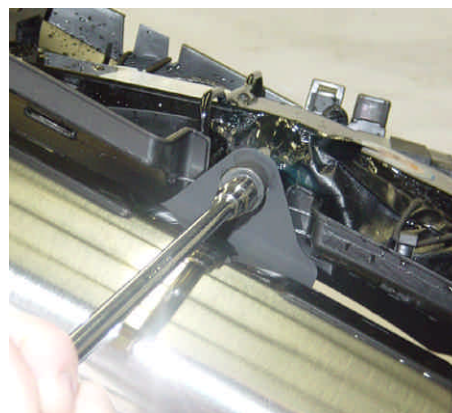

Figure 12



Figure 13



Figure 14



Figure 15

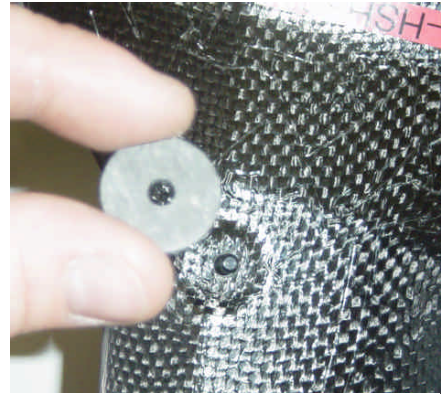

Figure 16

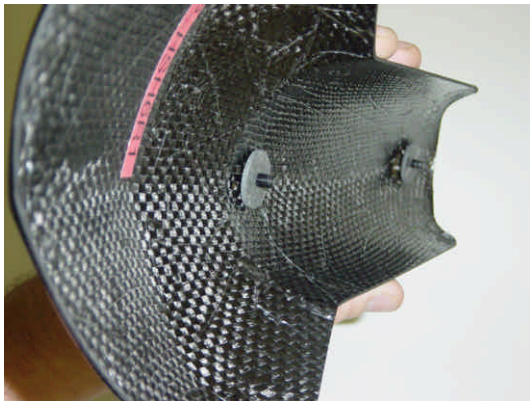

Figure 17



Figure 18

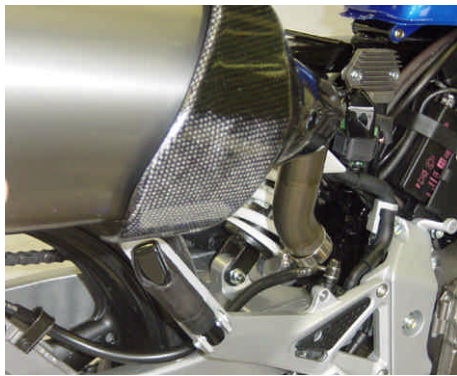

Figure 19

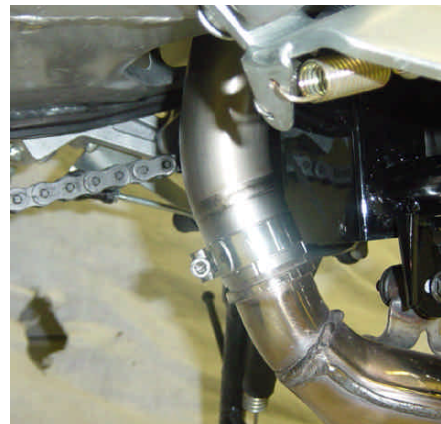

Figure 20



Figure 21



Figure 22



Figure 23

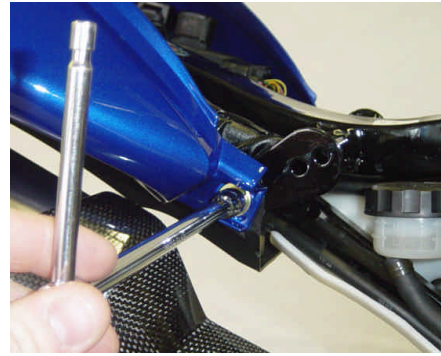

Figure 24

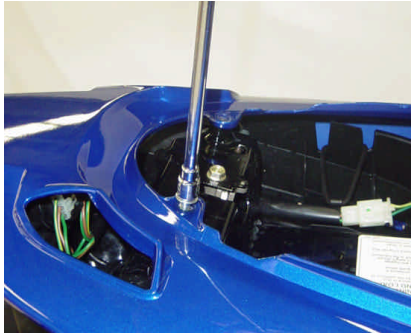

Figure 25



Figure 26



Figure 27

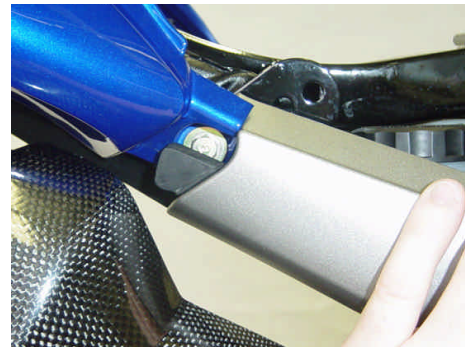

Figure 28



Figure 29



Figure 30

HONDA CB 600 HORNET Slip-on exhaust system/SP series, model year: 1998-2002

Product code: 102338 (SS-H6SO3-HDT)

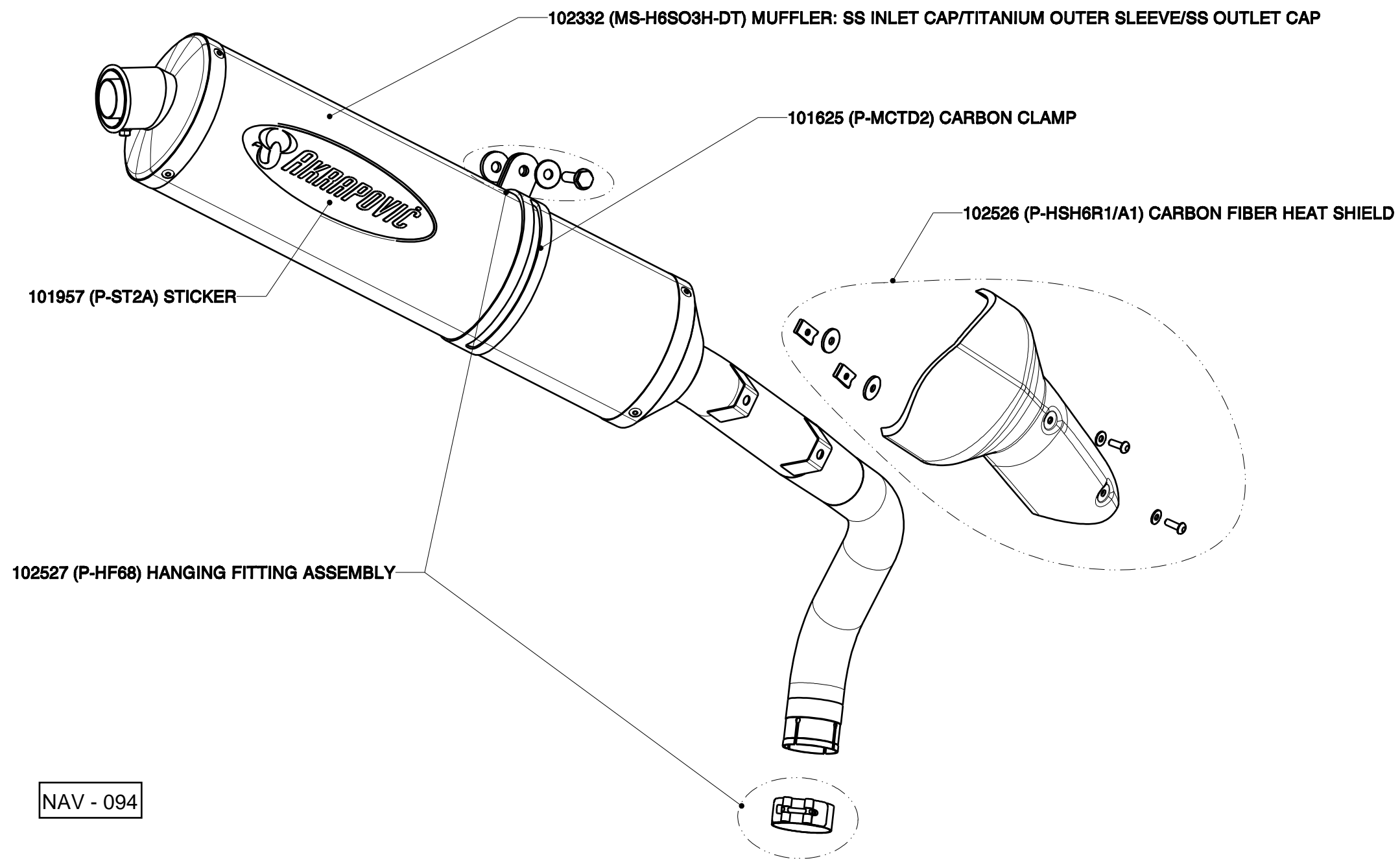

WARNING:

Please note that certain aftermarket exhaust systems may not comply with applicable California laws and regulations, and may therefore be prohibited for use on California highways or roads, or on roads or vehicles otherwise subject to emissions control requirements.

Akrapovič exhaust systems for automobiles and motorcycles mounted downstream of the catalytic converter (also known as “cat-back systems”) are considered “replacement parts” in California by the California Air Resources Board (CARB), and do not require an exemption or executive order from CARB to be sold in California. However, California prohibits the use of any aftermarket exhaust system that modifies, removes or replaces original equipment catalysts, unless CARB has issued an Executive Order as to such part or system.

Further, Akrapovič parts or exhaust systems used or intended for use on “racing vehicles” (i.e. a competition vehicle used exclusively for competition on closed-course circuits) do not require an exemption or Executive Order from CARB to be sold in California. However, such parts are prohibited from use on California public highways or roads, even if occasionally used “off-road.”