

## Installation instructions:



# AKRAPOVIC SLIP-ON & SLIP-ON SP SERIES EXHAUST SYSTEM for the BMW K1200 S, R (2005-) ; K1200 R Sport (2007)

**Congratulations on purchasing an Akrapovic exhaust system. Please read these installation instructions carefully. If you have any trouble installing the system please contact your authorized dealer!**

### **IMPORTANT INFORMATION**

#### **Exclusion of Certain Liability**

1. The manufacturer, importer or dealer shall not be liable for any incidental damage including personal injury or any other damages caused by improper installation or operation of the Akrapovic exhaust system. When installing the Akrapovic exhaust system be careful that the exhaust system does not touch other parts sensitive to high temperature.
2. Akrapovic makes no representation or warranties with regard to damage caused by the improper installation, use and maintenance of the Akrapovic exhaust system. The warranty is limited to defects recognized by our technical department and to normal use, and excludes items subject to normal wear (gaskets and damping wool). The guarantee is void in case of accident, modification, improper or competition use.
3. Do not attempt to install the Akrapovic exhaust system on a motorcycle for which it was not made or tested by Akrapovic.
4. When the exhaust system gets very hot during operation, be careful not to burn yourself on the exhaust system or parts which are in direct contact with it, even when the motor is not running. Also protect other people, especially children, from the injuries mentioned above.
5. In some cases Akrapovic exhaust system kits contain chemical products (ceramic anti-seizing grease; bolt sealant). Handle with care, do not inhale or swallow. Avoid excessive contact with skin, eyes or mucous membranes. Keep out of reach of children.
6. Technical specifications of Akrapovic exhaust systems and related products subject to change without notice.

#### **Trademarks**

The Akrapovic Exhaust System Technology logo is a registered trademark of Akrapovic d.å.

#### **Akrpovic website**

Information about Akrapovic exhaust systems and related products is available on the Akrapovic website at:  
**<http://www.akrapovic-exhaust.com/>**

#### **Copyright**

No part of the Akrapovic exhaust system or its documentation may be reproduced or distributed in any form or by any means without the prior written authorization of the Akrapovic company.

© Akrapovic d.å. All rights reserved.





#### **Symbols**

The following symbols are used throughout these installation instructions:

**! CAUTION OR WARNING**

** INSTALLATION TIP**

## **INSTALLATION INSTRUCTIONS**

- |   |   |
|---|---|
|  | <b>BEFORE INSTALLING CHECK SCHEMATIC OF THE EXHAUST SYSTEM!</b>   |
|  | <b>IF ANY ITEMS IN THE AKRAPOVIC EXHAUST SYSTEM PACKAGE ARE MISSING PLEASE CONTACT YOUR AUTHORIZED DEALER. KEEP THE SCHEMATIC FOR FUTURE REFERENCE.</b>                             |
|  | <b>THESE INSTALLATION INSTRUCTIONS MUST BE READ CAREFULLY IN ORDER TO ENSURE PROPER INSTALLATION AND OPERATION OF THE AKRAPOVIC EXHAUST SYSTEM.</b>                                 |
|  | <b>THE EXHAUST SYSTEM CAN BE EXTREMELY HOT. ALLOW THE MOTORCYCLE TO COOL DOWN BEFORE BEGINNING INSTALLATION.</b>  |
|  | <b>WE ADVISE YOU TO LEAVE INSTALLATION TO A QUALIFIED SERVICEMAN. IMPROPER INSTALLATION MAY RESULT IN A SHORTER LIFETIME OF THE EXHAUST SYSTEM AND/OR DAMAGE TO THE MOTORCYCLE.</b> |

### **REMOVAL OF STOCK EXHAUST SYSTEM**

1. put the motorcycle on a side stand, we recommend a racing stand
2. unscrew the bolt of the heat shield from the link pipe and remove the heat shield (**Figure 1, 2**)
3. unscrew the bolt from the metal clamp at the muffler - link pipe joint (**Figure 3**)
4. unscrew the bolt from the muffler metal clamp and remove the muffler (**Figure 4, 5**)

### **INSTALLATION OF THE AKRAPOVIC SLIP-ON EXHAUST SYSTEM**

#### **installing the independent link pipe:**

1. correctly position and slide the Akrapovic link pipe onto the stock collector (**Figure 6**)
2. correctly install the stock metal clamp and hand tighten the bolt of the stock metal clamp (**Figure 7**)



#### **installing the muffler:**

1. position the muffler correctly and slide it onto the outlet side of the link pipe (**Figure 8**)
2. correctly position the carbon-fiber clamp and slide it onto the muffler, bear in mind the **left offset** of the carbon-fiber clamp viewed from the rear **WARNING:** open the clamp to slightly wider than the diameter of the outer sleeve of the muffler – do not scrape it along the muffler outer sleeve! (**Figure 9**)
3. tighten the carbon-fiber clamp onto the stock chassis hanging bracket on the frame - use the bolt and washers supplied in the Akrapovic kit. Do not fully tighten. Make sure the additional parts from the Akrapovic kit are correctly installed. (**Figure 10, 11**)
4. press the link pipe onto the stock collector one more time and tighten fully the bolt of the metal clamp (**Figure 12, 13**)
5. attach the springs at the Akrapovic muffler - link pipe joint (**Figure 14**)
6. tighten fully the Akrapovic carbon-fiber clamp (**Figure 15**)
7. make sure the muffler is not touching other parts of the motorcycle

#### **final installation:**

1. clean grease spots:
  - a. muffler – titanium outer sleeve: use a soft cloth sprayed with a multi-purpose spray lubricant (WD-40 or equivalent)
  - b. muffler – carbon-fiber outer sleeve: use a soft dry cloth
  - c. stainless steel link pipe: use a soft cloth sprayed with a contact cleaner, then wipe with a soft dry clothCleaning will prevent spots from burning onto the surface. Do not use aggressive chemical cleaners, because they can damage the sticker.
2. position of the installed Akrapovic Slip-on system (**Figure 16, 16a, 16b**)

**Check the operation of the brakes and suspension. Make sure all the bolts are sufficiently tightened. In case the exhaust system touches the cowling or other parts repeat the adjustment of the exhaust system or contact your authorized dealer.**

- |   |   |
|---|---|
|  | <b>IT IS NORMAL IF WHITE SMOKE COMES OUT OF THE MUFFLER ON FIRST OPERATION.</b>   |
|  | <b>DO NOT STAND BEHIND THE MUFFLER ON FIRST OPERATION.</b>  |
|  | <b>DO NOT USE AUTOMOTIVE WHEEL CLEANERS OR ANY CLEANING PRODUCTS WHICH CONTAIN ACIDIC ADDITIVES TO CLEAN AKRAPOVIC EXHAUST SYSTEMS.</b> |

### **MAINTENANCE OF THE AKRAPOVIC EXHAUST SYSTEM**

1. Clean the titanium muffler outer sleeve with a multi-purpose spray lubricant (WD-40 or equivalent ) and carbon fiber outer sleeve with soft and dry cloth. Do not use aggressive chemical cleaners, because they can damage the sticker. A change in the color of the exhaust system is normal due to the high temperatures.
2. The wearing out of the muffler silencing material depends on the type of the motor and riding style. Contact your dealer/serviceman if visible changes appear on muffler's outer sleeve or the noise level is increased.
3. Periodically ensure that all the bolts and springs are sufficiently tight.

**Photos:**



**Figure 1**



**Figure 2**



**Figure 3**



**Figure 4**



**Figure 5**



**Figure 6**



**Figure 7**



**Figure 8**





Figure 9



Figure 10



Figure 11



Figure 12



Figure 13

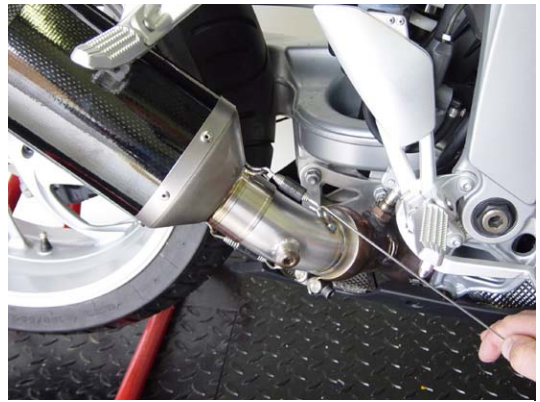

Figure 14



Figure 15



Figure 16



Figure 16a



Figure 16b

**BMW K1200S / K1200R / K1200RS, Slip-on exhaust system, Model year: 2005-2007**

**Product code: 104428 (S-B12SO1-C)  
104427 (S-B12SO1-T)**

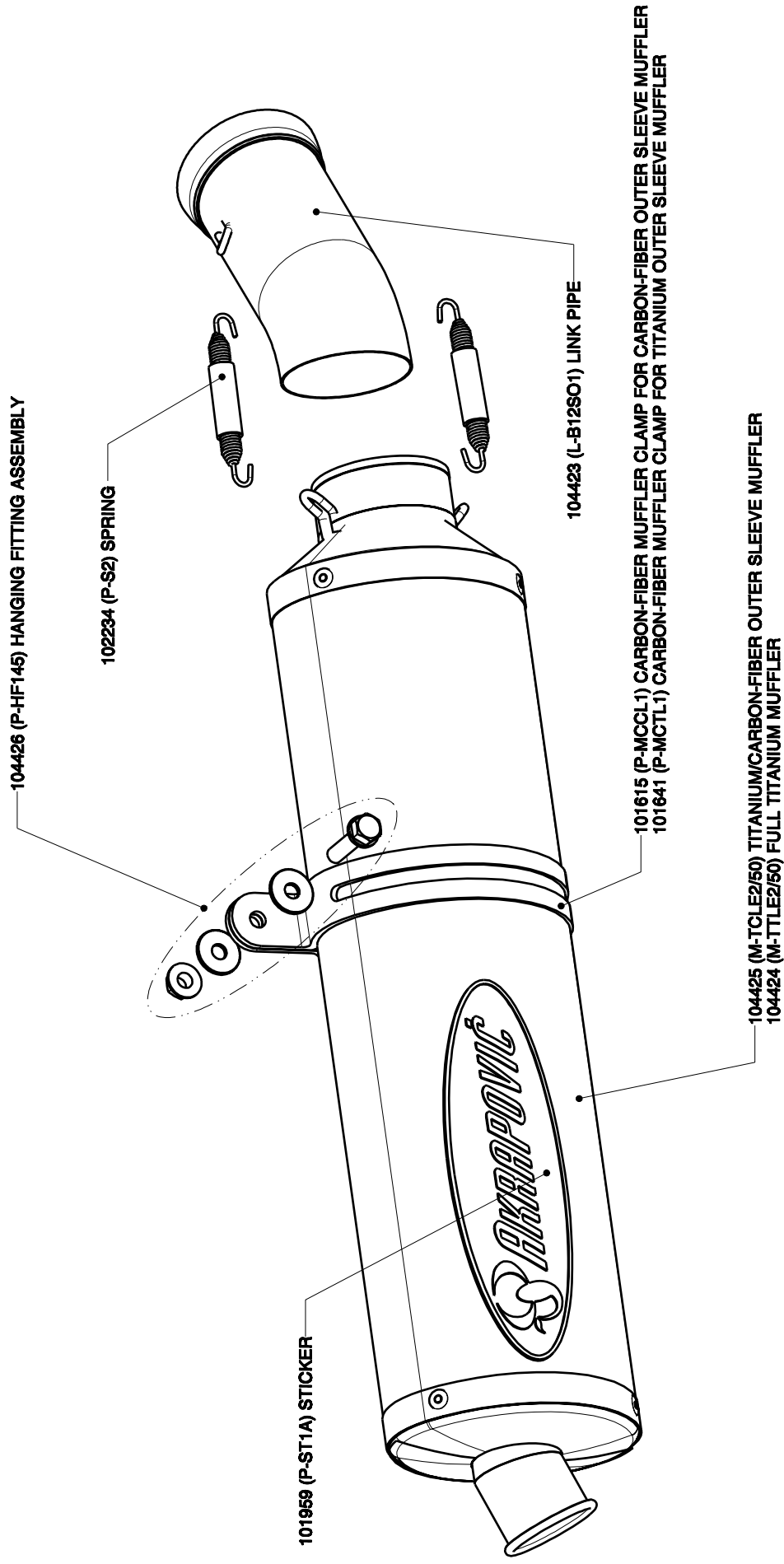

**BMW K1200S, K1200R Slip-on system/SP series/Street legal/Model year: 2005**

NAV - 179

**Product code: 104967 (SS-B12SO1-HC)  
104966 (SS-B12SO1-HT)**

