



Installation instructions

Akrapovič Exhaust System
Slip-On
for the
Aprilia SHIVER 750 2010



502649

Congratulations on purchasing an Akrapovič exhaust system. Please read the entire installation manual prior to undertaking any activities related to installation of your new Akrapovič exhaust system. In case you do not fully understand the manual or any of its parts, please contact your authorized dealer!

This product should be installed by someone with sufficient knowledge of exhaust systems and their installation, and appropriate hand or power tools. If you are not qualified for this work, please utilize a certified mechanic for installation. By installing Your Akrapovič exhaust system, you indicate that you have read the installation manual in its entirety and you agree with the terms stated herein.

It is your responsibility to follow all installation instruction guidelines supplied with the Akrapovič exhaust system and undertake all necessary safety precautions. Akrapovič d.d. assumes no responsibility for damages occurring from misuse, abuse, improper installation, improper operation, lack of responsible care, or all previously stated reasons resulting from incompatibility with other manufacturer's products and/or systems.

IMPORTANT INFORMATION

Exclusion of Certain Liability

1. The manufacturer, importer or dealer shall not be liable for any incidental damage including personal injury or any other damages caused by improper installation or operation of the Akrapovič exhaust system. When installing the Akrapovič exhaust system be careful that the exhaust system does not touch other parts sensitive to high temperature.
2. Akrapovič makes no representation or warranties with regard to damage caused by the improper installation, use and maintenance of the Akrapovič exhaust system. The warranty is limited to defects recognized by our technical department and due to normal use, and excludes items subject to normal wear (gaskets and damping wool). The guarantee is void in case of accident, modification, improper or competition use.
3. Do not attempt to install the Akrapovič exhaust system on a vehicle model for which it was not made or tested by Akrapovič.
4. When the exhaust system gets very hot during operation, be careful not to burn yourself on the exhaust system or parts which are in direct contact with it, even when the engine is not running. Also protect other people, especially children, from the injuries mentioned above.
5. In some cases Akrapovič exhaust system kits contain chemical products (ceramic anti-seizing grease; bolt sealant). Handle with care, do not inhale or swallow. Avoid excessive contact with skin, eyes or mucous membranes. Keep out of reach of children.
6. Technical specifications of Akrapovič exhaust systems and related products are subject to change without notice.
7. Before removing the original exhaust system from your vehicle, please compare the parts you received with the list of materials provided in the installation manual in order to assure that you have all the parts necessary for the installation of your new Akrapovič exhaust system.
8. Although this manual consists of instructions for installation in written form, as well as photographs and pictures representing individual steps of the installation, please note that the photographs and pictures are symbolic and are intended for representation of general overview only. The photographs and pictures contained herein should serve as a guideline only and actual installation of the exhaust system may not correspond with the photographs and pictures entirely.
9. The process of uninstalling the original exhaust system may vary depending on the existing exhaust system. Please follow the original exhaust system manufacturer's instructions for uninstalling the original exhaust system.

Trademarks

The Akrapovič Exhaust System Technology logo is a registered trademark of Akrapovič d.d.

Akrapovič website

Information about Akrapovič exhaust systems and related products is available on the Akrapovič website at: <http://www.akrapovic.com/>

Copyright

No part of the Akrapovič exhaust system or its documentation may be reproduced or distributed in any form or by any means without the prior written authorization of the Akrapovič company.

© Akrapovič, d.d. All rights reserved.

Symbols

The following symbols are used throughout these installation instructions:



TOOLS REQUIRED



TIGHTENING TORQUE



INSTALLATION TIP



CAUTION OR WARNING



USE BOLT SEALANT; Apply 3 to 4 small drops of bolt sealant onto the cleaned and degreased threads before tightening the bolts. **WARNING! Avoid contact with skin, eyes and mucous membranes. Do not inhale fumes. Keep out of reach of children.**



USE ANTI-SEIZE LEAD-FREE COPPER PASTE (black tube); Provides trouble-free and long-lasting protection against seizing, corrosion and rusting of bolts, threaded ends, nuts, joints, etc. Also protects against vibration, wear and impact. **WARNING! Avoid eye contact. Avoid excessive skin contact. Keep out of reach of children.**



USE ANTI-SEIZING GREASE (white tube); Prevents seizing, corrosion and excessive wear between the titanium components of your exhaust system. **WARNING! Avoid eye contact. Avoid excessive skin contact. Keep out of reach of children.**

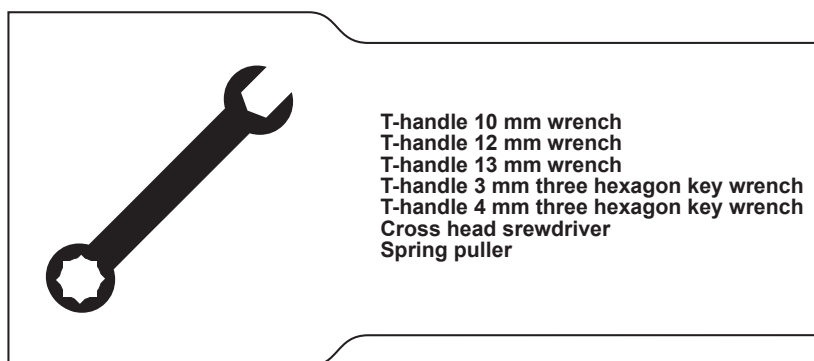

BEFORE INSTALLING, CHECK SCHEMATIC OF THE EXHAUST SYSTEM!



IF ANY ITEMS IN THE AKRAPOVIČ EXHAUST SYSTEM PACKAGE ARE MISSING, PLEASE CONTACT YOUR AUTHORIZED DEALER. KEEP THE SCHEMATIC FOR FUTURE REFERENCE.



THESE INSTALLATION INSTRUCTIONS MUST BE READ CAREFULLY IN ORDER TO ENSURE PROPER INSTALLATION AND OPERATION OF THE AKRAPOVIČ EXHAUST SYSTEM.



THE EXHAUST SYSTEM CAN BE EXTREMELY HOT. ALLOW THE EXHAUST AND ENGINE TO COOL DOWN BEFORE BEGINNING INSTALLATION.



WE ADVISE YOU TO LEAVE INSTALLATION TO A QUALIFIED SERVICEMAN. IMPROPER INSTALLATION MAY RESULT IN A SHORTER LIFETIME OF THE EXHAUST SYSTEM AND/OR DAMAGE TO THE VEHICLE.

REMOVAL OF STOCK EXHAUST SYSTEM:

1. Put the motorcycle on a side stand, we recommend a racing stand. Make sure, that surface is solid and flat.
2. Remove the seat. Cut the two plastic tie wraps from rear lighting electrical cable. Unscrew the marked bolts and remove the plastic connector cover (Figure 1).



Figure 1

3. Unscrew all marked bolts and disconnect the two marked electrical connectors. Remove the passenger handle (Figure 2).

! **WARNING:** make sure not to damage any part of the motorcycle during this process!



Figure 2

4. Unscrew the marked bolts and remove the license plate bracket with taillamp (Figure 3, 4).



Figure 3



Figure 4

5. Unscrew the marked bolts on both sides of the motorcycle. Unhook the seat lock cable from the left side muffler cowling and remove the muffler cowlings from the motorcycle (Figure 5, 6).



Figure 5



Figure 6

6. Unscrew the marked muffler bracket bolts (Figure 7).



Figure 7

7. Untighten the bolt of the metal clamp at the muffler-link pipe joint and pull the stock muffler off the motorcycle (Figure 8, 9).
! WARNING: support the muffler during this procedure or it may fall off and damage you or the motorcycle!



Figure 8



Figure 9

8. Remove the two marked press on nuts (Figure 10).



Figure 10

9. For optional mudguard only: unscrew and remove the battery cover (Figure 11).

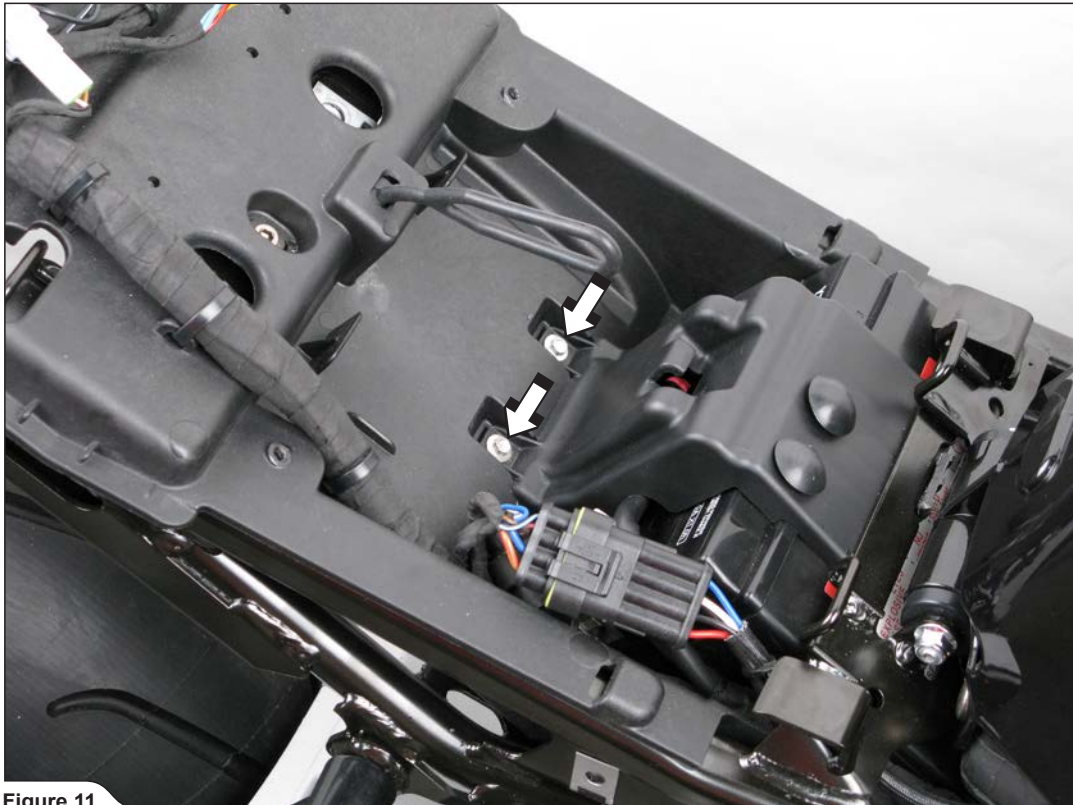

Figure 11

10. For optional mudguard only: remove the two marked press on nuts (Figure 12).



Figure 12

INSTALLATION OF THE AKRAPOVIČ SLIP-ON EXHAUST SYSTEM:

1. Install Akrapovič graphite gasket into the link pipe and correctly install the stock clamp onto the link pipe (**Figure 13**).
! WARNING: use anti-seize copper paste on stock clamp bolt threads!



Figure 13

2. Correctly assembled Akrapovič mufflers bracket (**Figure 14**).

! WARNING: make sure, that aluminium spacers grooves are oriented toward mufflers bracket!



Figure 14

3. **For optional mudguard only:** correctly assembled Akrapovič mufflers bracket and optional mudguard (**Figure 15**).



Figure 15

4. Assemble the license plate bracket with taillamp and muffler cowlings back onto the motorcycle as shown (**Figure 16**).
! WARNING: make sure, that you attach the seat lock cable back onto the left side muffler cowling lock!

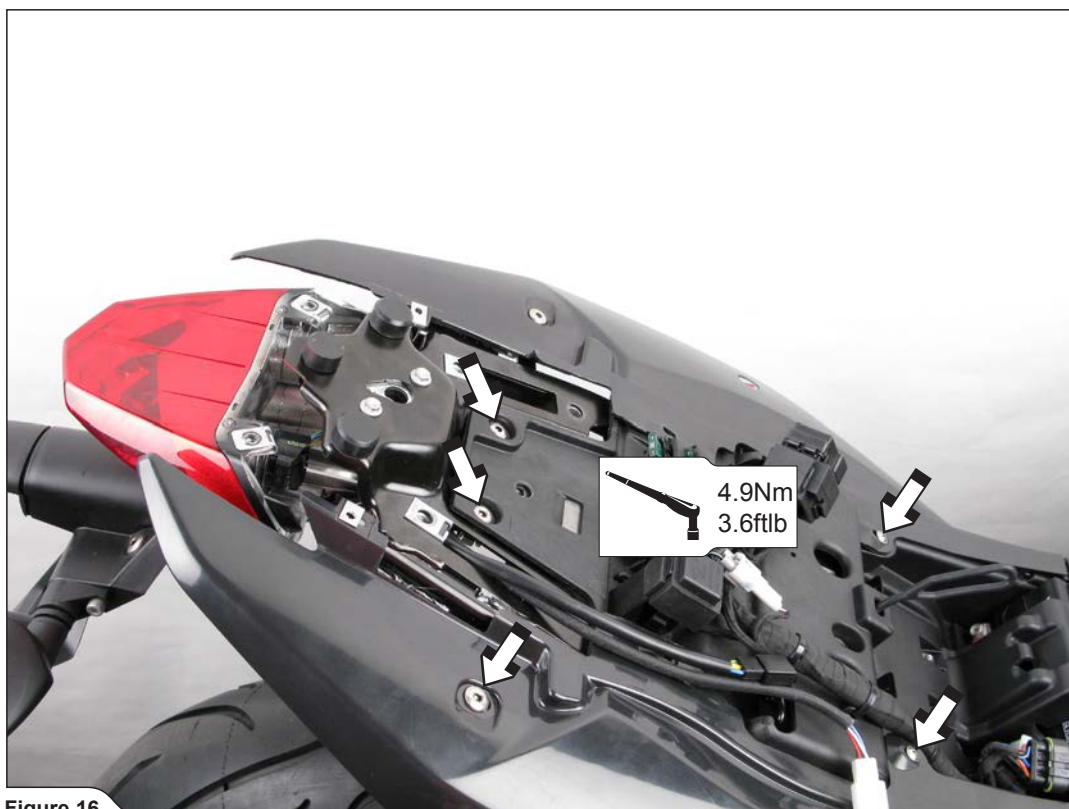

Figure 16

5. Install the stock passenger handle back onto the motorcycle. Tighten the mark bolts (**Figure 17**).



Figure 17

6. Install the Akrapovič muffler bracket (check Figures 14, 15 for correct assembly) onto the motorcycle (**Figure 18**).

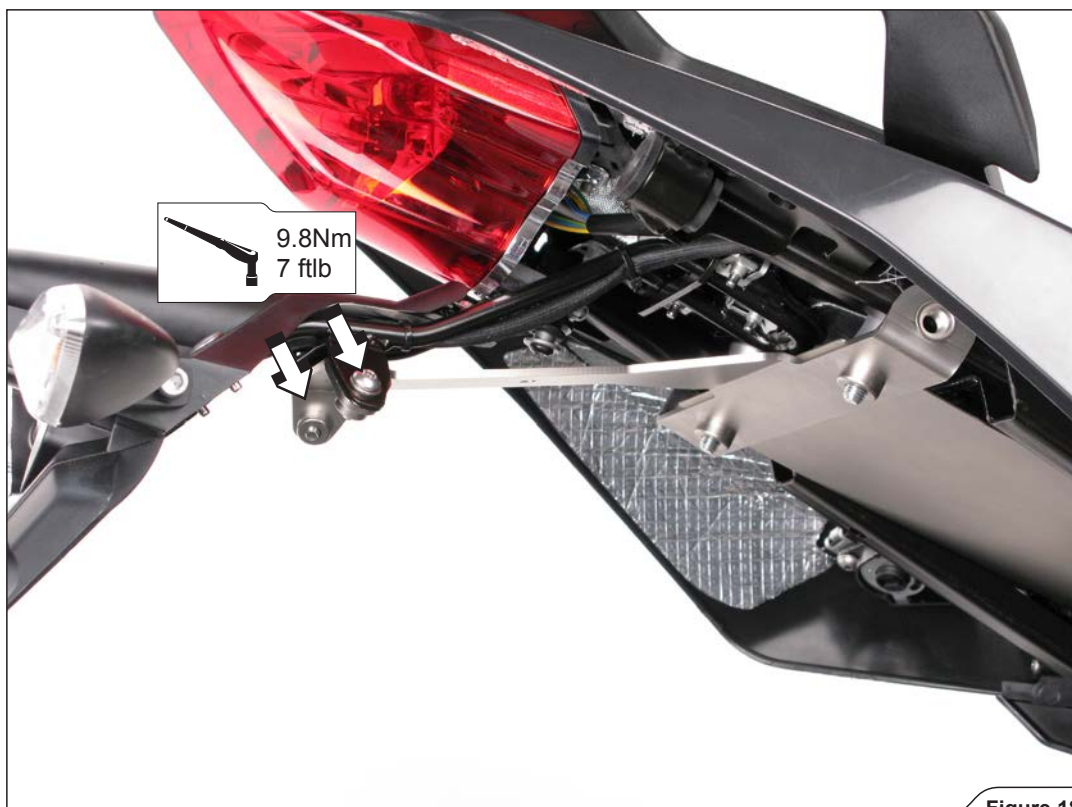

Figure 18

7. **For optional mudguard only:** assemble the battery cover and tighten it together with optional mudguard, using stock M4 bolts and Akrapović M4 nuts and washers (**Figure 19**).



Figure 19

8. Tighten the mufflers bracket bolts to a specified torque, reconnect the electrical connectors and secure the electrical wires as shown, using plastic tie wraps (**Figure 20**).

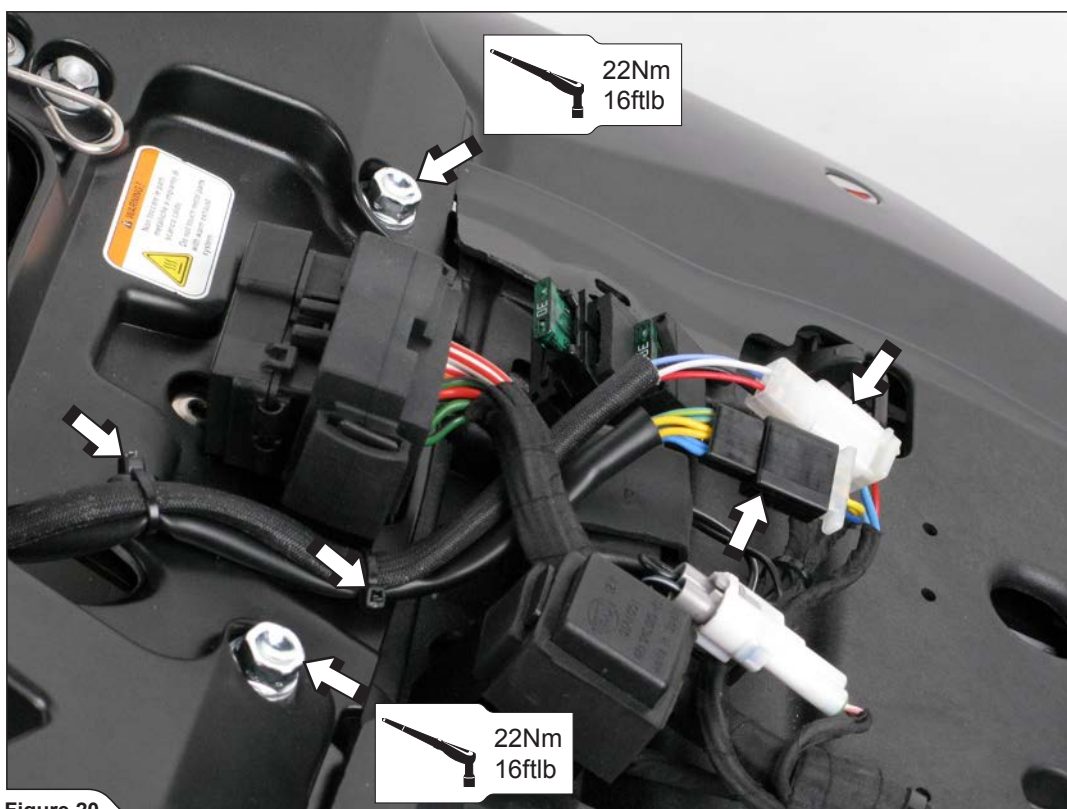

Figure 20

9. Reinstall the the plastic connector cover and tighten the lower muffler cowling bolts on both sides of the motorcycle (Figure 21).

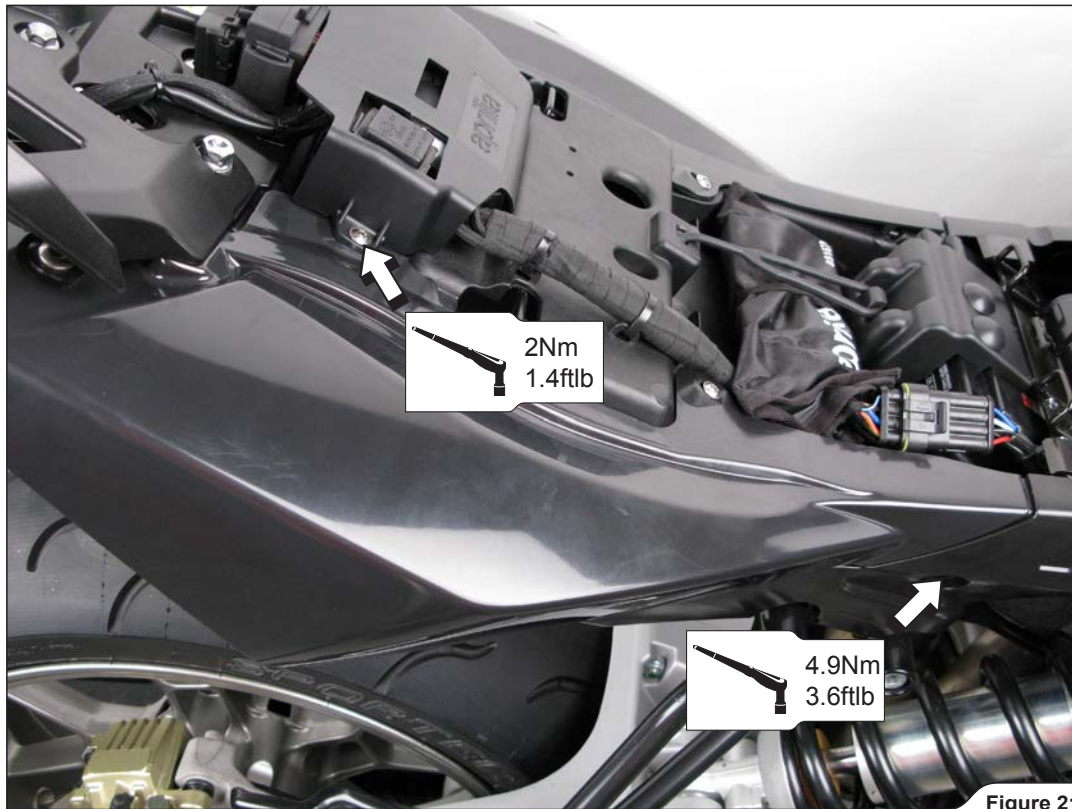

Figure 21

10. Correctly position and slide the link pipe onto the stock collector and hand tighten the stock metal clamp (Figure 22).



Figure 22

11. Correctly position the carbon-fiber clamps, as shown and slide them onto the mufflers (Figure 23).
! **WARNING:** use TD42 clamp for the left muffler and TD36 clamp for the right one. The yellow stickers should be oriented as shown!
! **WARNING:** when slid onto the mufflers, open the clamps slightly wider than the diameter of the outer sleeves of the mufflers – do not scrape them along the muffler outer sleeves!



Figure 23

12. Position the mufflers correctly and slide them onto the outlet sides of the link pipe. Attach the springs, align the mufflers in respect to the motorcycle and tighten the carbon fiber clamps onto the mufflers bracket, using M8x20 bolts and washers (Figure 24).
! **WARNING:** before tightening the muffler clamp bolts, make sure, that springs pull the mufflers all the way onto the link pipes – use rubber mallet if necessary to tap the connections into place!



Figure 24

13. Tighten the stock metal clamp to a specified torque (**Figure 25**).

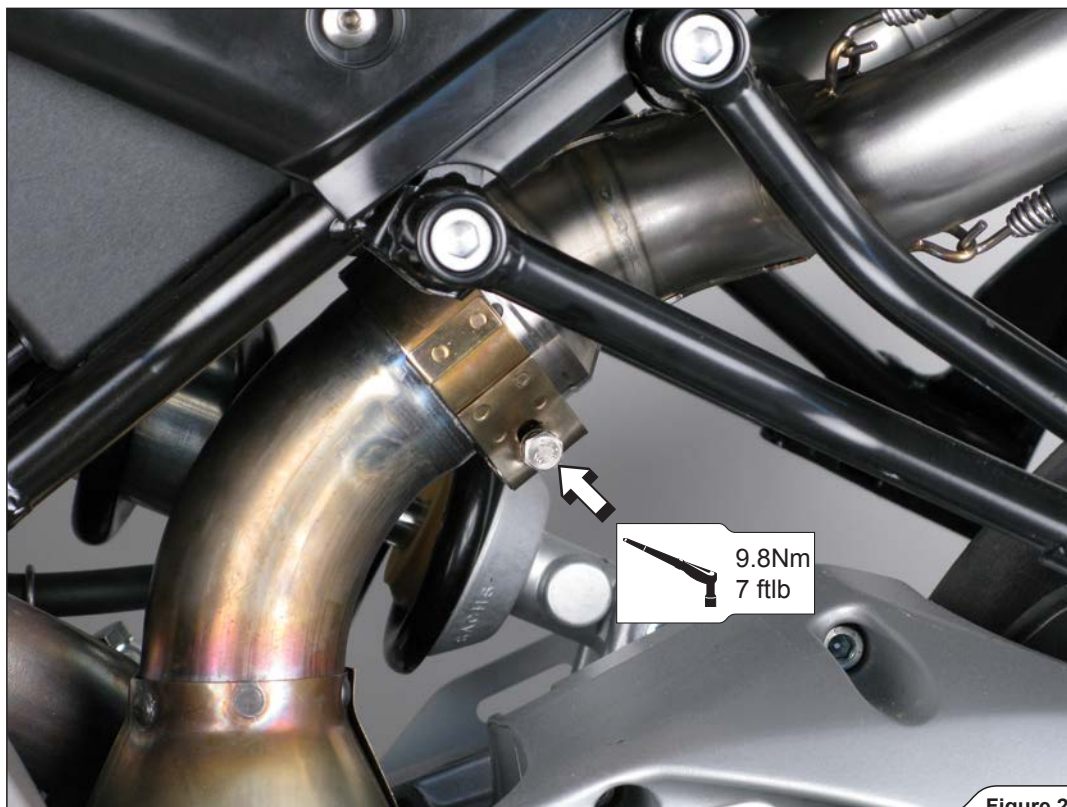

Figure 25

14. In case the mufflers can't be centred in respect to the motorcycle, untighten the bolts of all exhaust clamps (metal and carbon fiber), adjust all exhaust components and then tighten all clamps (**Figure 26**).

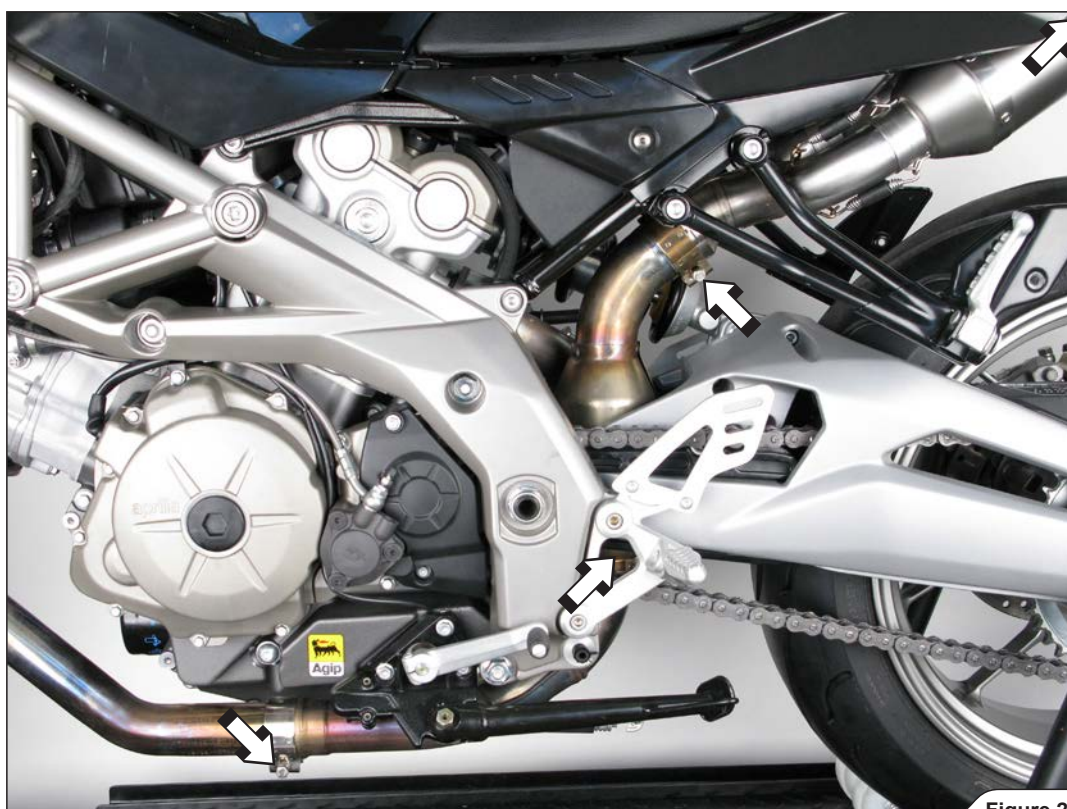

Figure 26

Final installation:

Clean grease spots:

- Muffler – titanium outer sleeve: use a soft cloth sprayed with a multi-purpose spray lubricant (WD-40 or equivalent).
- Muffler – carbon-fiber outlet cap: use a soft dry cloth.
- Slip-On with stainless steel link pipe: use a soft cloth sprayed with a contact cleaner, then wipe with a soft dry cloth

Cleaning will prevent spots from burning onto the surface. Do not use aggressive chemical cleaners, because they can damage the sticker.

! **WARNING: make sure all the bolts are sufficiently tightened. In case the exhaust system touches the cowling or other parts repeat the adjustment of the exhaust system or contact your authorized dealer.**

! **WARNING: check vehicle manufacturer manual for tightening torques (for dismantled stock parts)!**

! **IT IS NORMAL IF WHITE SMOKE COMES OUT OF THE MUFFLER ON FIRST OPERATION.**

! **DO NOT STAND BEHIND THE MUFFLER ON FIRST OPERATION.**

! **DO NOT USE AUTOMOTIVE WHEEL CLEANERS OR ANY CLEANING PRODUCTS WHICH CONTAIN ACIDIC ADDITIVES TO CLEAN AKRAPOVIČ EXHAUST SYSTEMS.**

MAINTENANCE OF THE AKRAPOVIČ EXHAUST SYSTEM:

- Clean the titanium exhaust components with a multi-purpose spray lubricant (WD-40 or equivalent), carbon fiber exhaust components with soft and dry cloth and stainless steel components with soft cloth sprayed with contact cleaner, then wipe with soft and dry cloth. A change in the color of the exhaust system is normal due to the high temperatures.
- Periodically make sure all the bolts and springs are sufficiently tight.

